



— 2026 —

# SWIM SPAS

1302

1400

1401

1600

1700

2100

Coast Spas Manufacturing  
6315 202 Street, Langley BC  
Canada 604 514 8111  
[info@coastspas.com](mailto:info@coastspas.com)  
[www.coastspas.com](http://www.coastspas.com)



## WORLD'S BEST BUILT SPAS

Here at Coast Spas we have over 25 years of experience crafting the World's Best Built Spas®. Our mission is to deliver the highest quality spas with exceptional performance to help improve your overall wellness. We are so glad you've chosen a Coast Spa and we hope you, your family and friends all enjoy it for years to come.

*Thank you for choosing us!*



**CONGRATULATIONS!**

**YOU'RE ALMOST READY TO ENJOY YOUR NEW SPA!**

Before you begin to enjoy your swim spa, please take a moment to submit your swim spa warranty. For registering your swim spa, you will need the swim spa serial number. Picture below will help you locate the serial number on your swim spa.



You can register your swim spa by using below link.

<https://coastspas.microsoftcrmportals.com/>

**FOR YOUR REFERENCE**

Swim Spa owner name: \_\_\_\_\_

Address: \_\_\_\_\_

Contact: \_\_\_\_\_ Email: \_\_\_\_\_

Swim Spa Serial number: \_\_\_\_\_ Purchase Date: \_\_\_\_\_

Delivery Date: \_\_\_\_\_ Dealer Name: \_\_\_\_\_

Contact your swim spa selling dealer if you have any queries related to your swim spa. Coast spas authorized dealers are trained professionals who can assist you with swim spa parts, setup, operations, maintenance, and technical support.

**DISCLAIMER:** At the time of print, this manual is accurate in its information. Coast Spas reserves all the rights to change/modify any spa designs and/or features without notification. To check on updates or for other information, please visit [www.coastspas.com](http://www.coastspas.com)

## TABLE OF CONTENTS

Coast Spas Thank You! letter	Page	2
Registering your Swim spa	Page	3
Table of contents	Page	4
Basic information	Page	5
Important safety instructions and glossary of terms	Page	6-8
Preparation, set-up and location of your new Swim spa	Page	8-13
Swim spa general layout	Page	14
Swim spa features	Page	15
Start up guide—Swim and Exercise spas, Infinity Edge swim spas	Page	16-17
Swim spa care guide	Page	18-20
Basic installation and configuration guidelines : Electrical requirements	Page	20-21
Swim spa maintenance procedures	Page	21-22
Diverter and jet maintenance	Page	23
Coast Spas Chemicals	Page	24-25
Troubleshooting guide	Page	26-28
Draining & Winterizing	Page	29
Swim spa controls	Page	30-35
Swim spa specifications	Page	36
Swim spa jet operations	Page	37-42
Balboa Wi-Fi module	Page	43
ControlMySpa™	Page	44-47
Balboa Bluetooth Audio (bba™)	Page	48-50
Coast Status	Page	51-52
EcoClean UV sterilizer	Page	53
Swim spa exercise guide - 1300   1400   1700	Page	54
Swim spa exercise guide - 1600   2100	Page	55
Swim spa service log	Page	56

**IMPORTANT GFCI INFORMATION**

Based on the testing conducted by the supplier of the true variable speed pumps, the Siemens brand GFCI can filter electrical spikes and avoid false trips. The use of a 60 Amp Siemens GFCI is recommended with the Atlas Swim System.



**PLEASE READ YOUR ENTIRE OWNER'S MANUAL BEFORE SPA OPERATION**



## BASIC INFORMATION

### WATER CARE

**IMPORTANT:** Caring for your water by ensuring proper chemical usage is the single most important thing you can do to keep your swim spa in good condition.

**WARNING:** Improper chemical usage and maintenance will quickly lead to severe issues with your spa and can effect the spa equipment, jets, pumps, and all other components in contact with the spa water.

**All spas and swim spas are susceptible to damage from unbalanced spa water.**

Always maintain your water chemistry within the following parameters.

pH	7.2 - 7.8
Chlorine	1.0 - 3.0 ppm
Bromine	2.0 - 5.0 ppm
Total Alkalinity	100 - 120 ppm
Calcium Hardness	150 - 250 ppm

### ELECTRICAL

**All self contained spas use 120VAC or 240VAC electrical spa packs.**

**120VAC:** Requires an isolated 15 Amp circuit breaker, an isolated circuit with no other appliances or lights on the circuit at any time. Extension cords are not to be used in conjunction with the operations of the swim spa. Low voltage damage could result and this is not covered under warranty. **IMPORTANT: Spas with 110V means that the jets and heater will not work at the same time.**

**NOTE:** All components must be 120V. No 240V components allowable.

**240VAC:** Depending on the model of the spa, it will require either a 40, 50, or 60 Amp dedicated circuit breaker with the proper wire size (gauge) based on the length of the run.

**The electrical circuit must be installed by a certified electrician and approved by a local building or electrical inspector.**

### SURFACE

Your new portable swim spa must be placed on a firm, flat and level surface, so that the weight is supported uniformly. We recommend no less than a 3" (93 mm) thick concrete slab. Wood decking or balconies must be constructed to support 150 pounds per square foot (730 kg/m<sup>2</sup>). Refer to the local and current building codes in your area. Should your new swim spa need to go through the gate or space –restricted area, ensure you've communicated those limitations with your dealer to avoid delivery complications.

**NOTE:** Damage caused by alternate decking methods may void the spa warranty. Contact your dealer if you have any questions regarding spa location and placement.

### TRANSPORT

Your new swim spa has left the factory cleaned and polished and ready to begin operation after passing our many quality and operational tests. However, depending on your location in the world, your swim spa may have spent days or even weeks in transit before arriving at your home. Please ensure that before filling or operating your spa that you check all electrical and plumbing connections are securely connected in the equipment area as they might have loosened during shipping. If any dirt has accumulated, you will want to remove with a clean cloth or sponge using warm water.

## IMPORTANT SAFETY INSTRUCTIONS

### READ AND FOLLOW ALL INSTRUCTIONS CAREFULLY

**DANGER: Risk of Injury.** The suction fittings in this swim spa are sized to match the specific water flow created by the pump. Should the need arise to replace the suction fittings or the pump, be sure that the flow rates are compatible. Never operate the spa if the suction fittings are broken or missing. Never replace a suction fitting with one rated less than the flow rate marked on the original suction fitting.

**DANGER: Risk of Accidental Drowning.** Do not allow children to be in or around the swim spa without adult supervision. Keep the swim spa cover on and locked when not in use. See instructions enclosed with the cover for locking procedures.

**DANGER: Risk of Electrical Shock.** The electrical supply for this product must include a suitably rated switch or circuit breaker to open all ungrounded supply conductors to comply with section 422-20 of the National Electrical Code, ANSI/NFPA 70. The disconnect must be readily accessible and visible to the spa occupant but installed at least 5 feet (1.5 m) from the swim spa water.

### READ, FOLLOW AND SAVE THESE INSTRUCTIONS

**a)** A green colored terminal or a terminal marked G, Gr, Ground, Grounding or the symbol \* is located inside the supply terminal box or compartment. To reduce the risk of electric shock, this terminal must be connected to the grounding means provided in the electric supply service panel with a continuous copper wire equivalent in size to the circuit conductors that supply this equipment.

**b)** At least two lugs marked "Bonding Lugs" are provided on the external surface or on the inside of the supply terminal box compartment. To reduce the risk of electric shock, connect the local common bonding grid in the area of the spa to these terminals with an insulated or bare copper conductor not smaller than No. 6 AWG.

**c)** All field-installed metal components such as rails, ladders, drains or other similar hardware within 5 feet (1.5 m) of the spa shall be bonded to the equipment grounding buss with copper conductors not smaller than No. 6 AWG.

**WARNING: To Reduce the Risk of Injury:** The water in a spa should never exceed 104 °F (40 °C). Water temperatures between 100 °F (38 °C) and 104 °F (40 °C) are considered safe

for a healthy adult. Lower water temperatures are recommended for young children and when spa use exceeds 10 minutes. Since excessive water temperatures have a high potential for causing fetal damage during the early months of pregnancy, pregnant or possibly pregnant women should limit spa water temperatures to 100 °F (38 °C). If pregnant, please consult your physician before using a spa. Before entering the spa, the user should measure the water temperature with an accurate thermometer since the tolerance of water temperature regulating devices may vary as much as +/- 5 °F (2 °C). Persons suffering from obesity or a medical history of heart disease, low or high blood pressure, circulatory system problems or diabetes should consult a physician before using the spa.

**CAUTION: Risk of Hyperthermia:** Hyperthermia occurs when the internal temperature of the body reaches a level several degrees above the normal body temperature of 98.6 °F (37 °C). The symptoms of hyperthermia include drowsiness, lethargy, and an increase in the internal temperature of the body. Prolonged immersion in hot water may induce hyperthermia. A description of the causes, symptoms, and effects of hyperthermia are as follows:

- Unawareness of impending hazard;
- Failure to perceive heat;
- Failure to recognize the need to exit spa;
- Physical inability to exit spa;
- Fetal damage in pregnant women; and
- Unconsciousness and danger of drowning.

**WARNING:** Children should not use the spa without adult supervision.

**WARNING:** Do not use the spa unless all suction guards are installed to prevent body and hair entrapment.

**WARNING:** People with infectious diseases should not use a spa.

**WARNING:** To avoid injury, exercise care when entering or exiting the spa.

**WARNING:** Do not use drugs or alcohol before or during the use of a spa to avoid unconsciousness and possible drowning. The use of alcohol or drugs can greatly increase the risk of fatal hyperthermia in spas.

**WARNING:** Pregnant or possibly pregnant women should consult a physician before using a spa.

**WARNING:** Water temperature in excess of 38 °C (100 °F) may be injurious to your health. Before entering the spa, measure the water temperature with an accurate thermometer.

**WARNING:** Do not use the spa immediately following strenuous exercise.

**WARNING:** Prolonged immersion in a spa may be injurious to your health.

**WARNING:** Do not permit electric appliances (such as lights, telephone, radio, television, etc.) within 5 feet (1.5m) of the swim spa unless such appliances are built-in by the manufacturer.

**WARNING:** People using medication and/or having an adverse medical history should consult a physician before using a swim spa.

**WARNING:** Maintain water chemistry in accordance with the manufacturer's instructions.

**WARNING:** The equipment and controls shall be located no less than 1.5 meters horizontally from the swim spa.

**WARNING:** This product can expose you to chemicals including Acrylonitrile, which is known to the state of California to cause cancer. For mor information, go to [www.P65Warnings.ca.gov](http://www.P65Warnings.ca.gov)

**CAUTION:** Observe a reasonable time limit when using the swim spa. Long exposures at higher temperatures can cause high body temperature. Symptoms may include dizziness, nausea, fainting, drowsiness, and reduced awareness. These effects could possibly result in drowning.

**CAUTION:** Enter and exit the swim spa slowly. Wet surfaces can be very slippery.

**CAUTION:** Proper chemical maintenance of swim spa water is necessary to maintain safe water and prevent possible damage to swim spa components. Maintain water chemistry in accordance with manufacturer's instructions.

**CAUTION:** Use the straps and clip tie downs to secure the cover when not in use. This will help to discourage unsupervised children from entering the swim spa and keep the swim spa cover secure in high-wind conditions. There is no representation that the cover, clip tie-downs, or actual locks will prevent access to the swim spa.

**CAUTION:** For exercise, the water should not exceed 90 °F (32 °C).

## GLOSSARY OF TERMS



**AIR CONTROL:** Mounted generally on the lip of the swim spa, it induces warm air from the equipment enclosure into the jet stream through venturi action.



**WATER DIVERTER:** The large diverter is used to divert water to various seats in the swim spa.



**FILTER AIR RELIEF VALVE:** Located on top of filter housing. Used to release air from the filter.



**SKIMMER BLEEDER VALVE:** Located inside the skimmer area or on the spa wall, needs to be loosened while filling the spa. This will help eliminate air from being trapped in the spa equipment.



**OZONATOR:** Available as an option. The ozonator produces natural ozone through the Corona Discharge process. Continuous use of an ozonator can dramatically reduce sanitizer consumption.



**CONTROL BOX (PACK):** Basically the "heart" of the spa. Power is distributed to any/all functions of the spa: pumps, ozonator, LED lighting, heater element, etc.



**CONTROL PANEL:** Mounted on the top lip of the spa and controls the functions of the spa.



**EQUIPMENT ENCLOSURE:** An enclosure that houses the control box, pump(s) and other electrical components.



**FILTER:** The filter cleans the spa by passing water through a filter cartridge where debris and impurities are removed. Top load filter means the filter cartridge is accessible through the top of the spa. Front access skimmer means cartridge is accessed through door of skimmer.

**DISCLAIMER:** The pictures displayed above are for reference purpose only. Some parts may be different depending upon the spa model.



**FLOOR DRAIN:** The floor drain is covered by a grate-type cover and is utilized when draining the spa. It also acts as the return for the ozonator. You will see bubbles emitted from this drain, which is the result of water mixing with the ozone output.



**GATE VALVES:** Red with a grey handle is located at the inlet and outlet of the pumping system. Used while servicing the spa equipment, the valves open or close the water flow to the equipment. To remain open for normal use, turn fully counterclockwise.



**KNIFE VALVES:** A white "T"-handled valve, same functions as Gate valve (see above), except to open them you pull up on handle.



**HEATER:** The electronically controlled heater raises the temperature of the spa to the desired setting.



**LEDs:** LEDs and their special lenses can be used to achieve the desired mood lighting in the spa and spa jets.

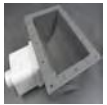

**SKIMMER:** This is the rectangular outlet at the water level. The skimmer removes surface debris to the filter. The water level in the spa should be kept  $\frac{1}{2}$  to  $\frac{3}{4}$  up on the skimmer for optimum operation.

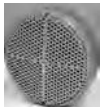

**SUCTION:** During operation of the equipment, the suction works in conjunction with the skimmer to draw water from the bottom of the spa through the filter, keeping the spa sparkling clean.



**NECK JET:** Direction-controllable jet for soothing neck massage.



**ADJUSTABLE CLUSTER JET:** Our adjustable, high-intensity hydrotherapy jet.



**DIRECTIONAL JET:** Provides a straight flow for a therapeutic massage



**ROTATIONAL JET:** Provides a Unidirectional circular therapeutic massage.



**MASSAGE JET:** Delivers massage in staccato bursts over a narrow, focused area.



**VOLCANO/WHIRLPOOL JET:** high-output jet designed for foot and leg massage.



**LAMINAR FLOW:** A thin stream of water that arcs from the spa lip.

## PREPARATION, SET-UP AND LOCATION FOR YOUR NEW SPA

- You want to keep in mind how you intend to use the spa and plan the location accordingly.
- How close is the spa from the exit or entrance to your house? (consider the cold weather)
- Is the path to your spa clean of debris, sand, grass? (so as not to track into the spa).
- Is there protection from wind, inclement weather?
- Can neighbors or passersby see the spa?

**NOTE:** *Allow for service access:* Many swim spa owners enjoy placing their spa in a decorative enclosure or a deck. Keep in mind that you need to have access to the equipment for maintenance and the swim spa should be able to be moved or lifted without destroying the special enclosure or its surroundings. You should discuss this with your dealer when designing the location. Extension cords are not to be used in conjunction with the operations of the spa. Low voltage damage could result and this is not covered by warranty.

**IMPORTANT:** For spas or hot tubs installed indoors, care should be taken to ensure adequate ventilation for the indoor space to avoid undesired buildup of humidity due to spa water. For additional information on ventilation and humidity guidelines, see the ASHRAE Handbook – HVAC Applications, I-P Edition, Sections 4.5, 4.6, and 4.7.

**DISCLAIMER:** The pictures displayed above are for reference purpose only. Some parts may be different depending upon the spa model.



## 1302 BENCH - SAFE HANDLING / UNLOADING INSTRUCTIONS

# CAUTION!



- Use 6" wide straps that are at least 30 feet in length to support the base of the swim spa during lifting.
- Ensure the straps are in good working condition prior to unloading the swim spa (ie. No rips, wear or tear).
- Ensure the straps are evenly spaced at 30" from each end (see diagram below). Spacing the straps may require slight adjustments to ensure the load is balanced.
- The chains attached to the crane must be a minimum of 18 feet in length from the point of lifting. Using chains smaller than 18 feet will add stress to the outer lip of the swim spa and may result in damage.
- Using the appropriately weighted straps and chains is important to ensure the safe handling of the 1300 BENCH Swim Spa. Please consult your crane operator for more information.

**Note:** Damage during transportation or from mishandling or improper lifting is not covered by the CSMI Warranty.

**Note:** Never lift or handle the spa by the swim plumbing or equipment.

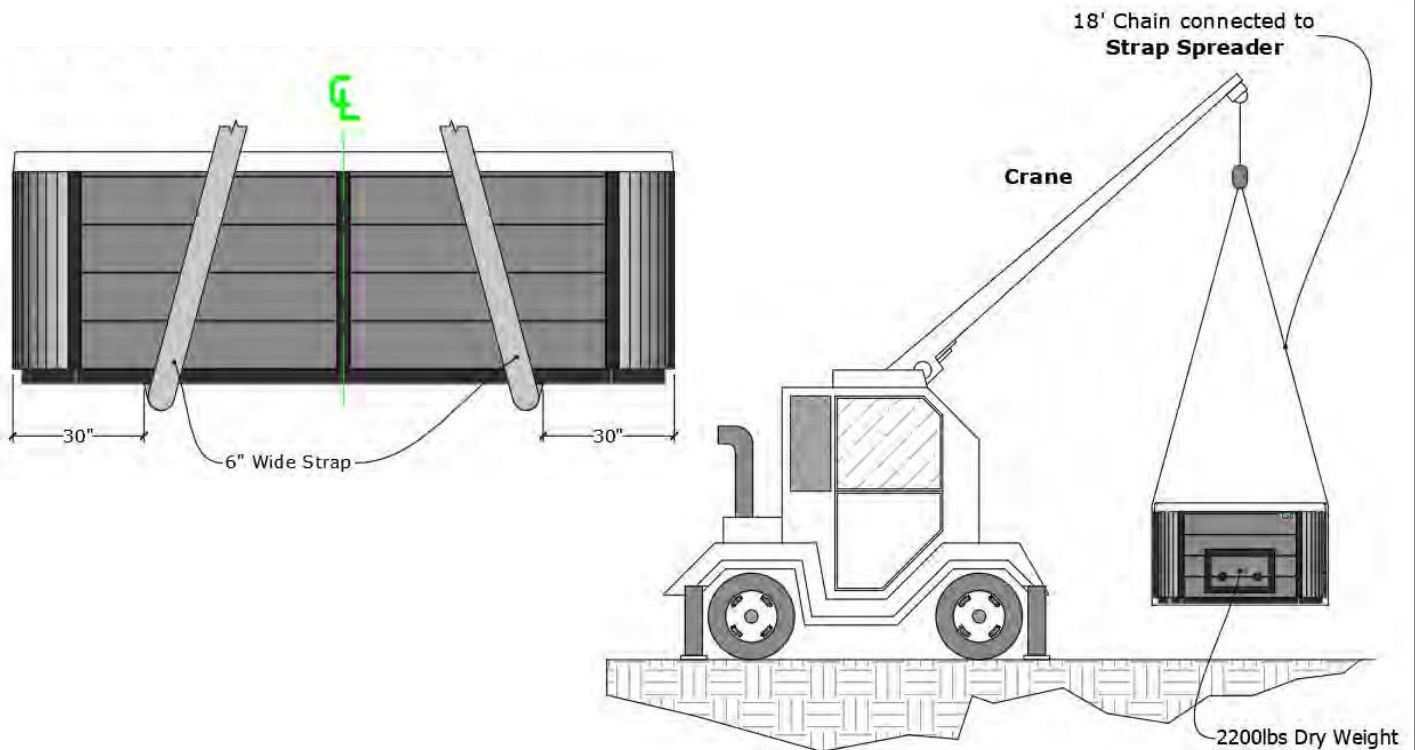



## 1400 VANISHING EDGE - SAFE HANDLING / UNLOADING INSTRUCTIONS

# CAUTION!



- Use 6" wide straps that are at least 30 feet in length to support the base of the swim spa during lifting.
- Ensure the straps are in good working condition prior to unloading the swim spa (ie. No rips, wear or tear).
- Ensure the straps are evenly spaced at 33" from each end (see diagram below). Spacing the straps may require slight adjustments to ensure the load is balanced.
- The chains attached to the crane must be a minimum of 18 feet in length from the point of lifting. Using chains smaller than 18 feet will add stress to the outer lip of the swim spa and may result in damage.
- Using the appropriately weighted straps and chains is important to ensure the safe handling of the 1400 VE Swim Spa. Please consult your crane operator for more information.

**Note:** Damage during transportation or from mishandling or improper lifting is not covered by the CSMI Warranty.

**Note:** Never lift or handle the swim spa by the plumbing or equipment.

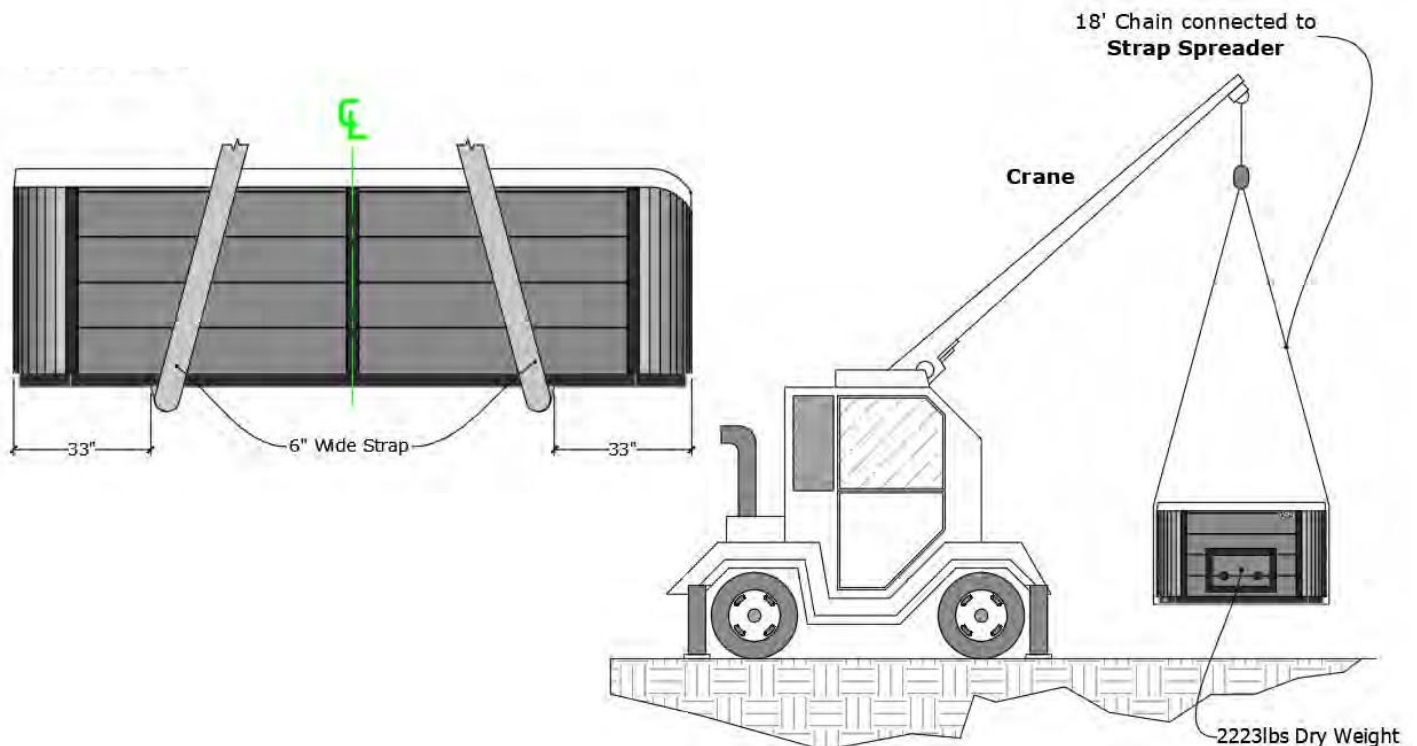



## 1600 - SAFE HANDLING / UNLOADING INSTRUCTIONS

# CAUTION!



- Use 6" wide straps that are at least 30 feet in length to support the base of the swim spa during lifting.
- Ensure the straps are in good working condition prior to unloading the swim spa (ie. No rips, wear or tear).
- Ensure the straps are evenly spaced at 40" from each end (see diagram below). Spacing the straps may require slight adjustments to ensure the load is balanced.
- The chains attached to the crane must be a minimum of 18 feet in length from the point of lifting. Using chains smaller than 18 feet will add stress to the outer lip of the spa and may result in damage.
- Using the appropriately weighted straps and chains is important to ensure the safe handling of the 1600 Swim Spa. Please consult your crane operator for more information.

**Note:** Damage during transportation or from mishandling or improper lifting is not covered by the CSMI Warranty.

**Note:** Never lift or handle the swim spa by the plumbing or equipment.

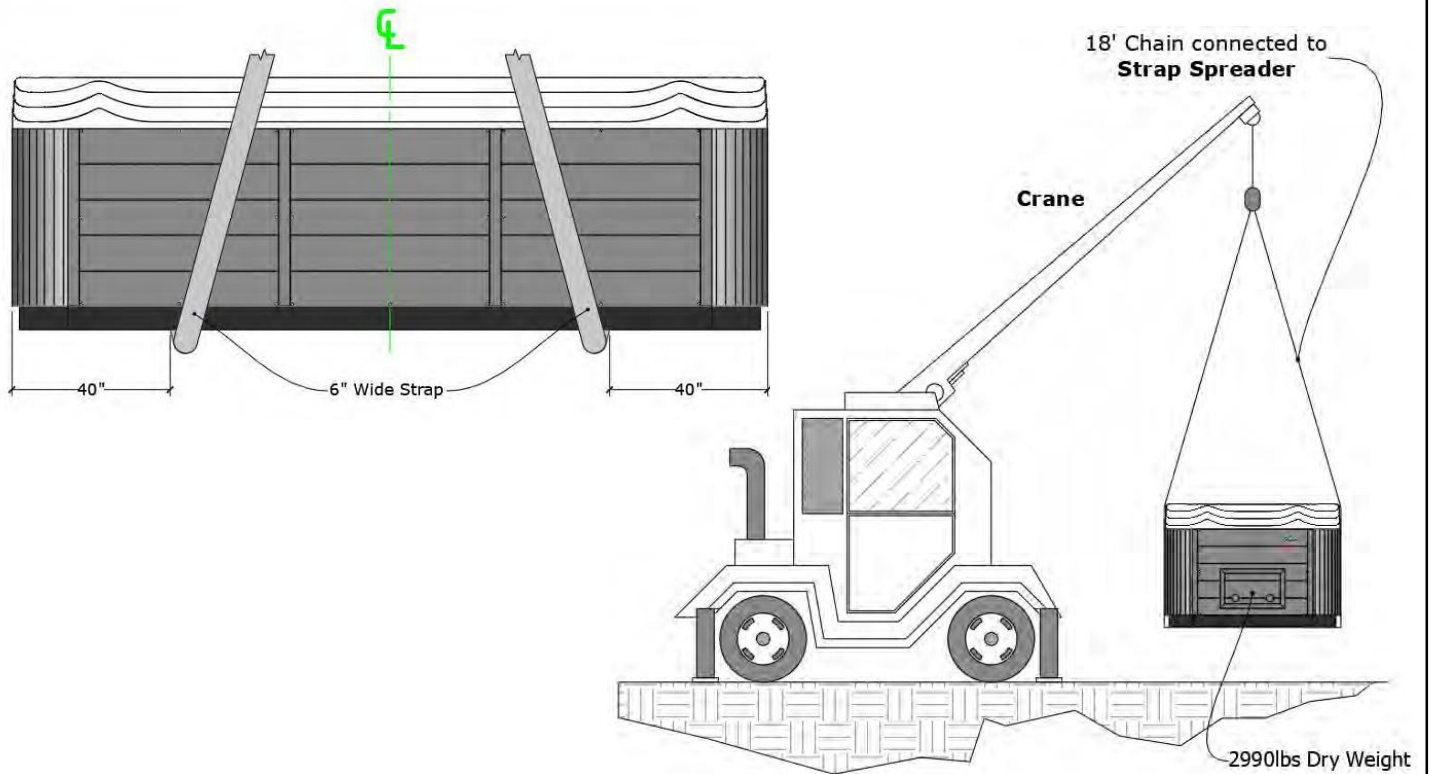



## 1700 INFINITY ULTRA - SAFE HANDLING / UNLOADING INSTRUCTIONS

# CAUTION



- Use 6" wide straps that are at least 30 feet in length to support the base of the swim spa during lifting.
- Ensure the straps are in good working condition prior to unloading the swim spa (ie. No rips, wear or tear).
- Ensure the straps are evenly spaced at 44" from each end (see diagram below). Spacing the straps may require slight adjustments to ensure the load is balanced.
- The chains attached to the crane must be a minimum of 18 feet in length from the point of lifting. Using chains smaller than 18 feet will add stress to the outer lip of the swim spa and may result in damage.
- Using the appropriately weighted straps and chains is important to ensure the safe handling of the 1700 IU Swim Spa. Please consult your crane operator for more information.

**Note:** Damage during transportation or from mishandling or improper lifting is not covered by the CSMI Warranty.

**Note:** Never lift or handle the swim spa by the plumbing or equipment.

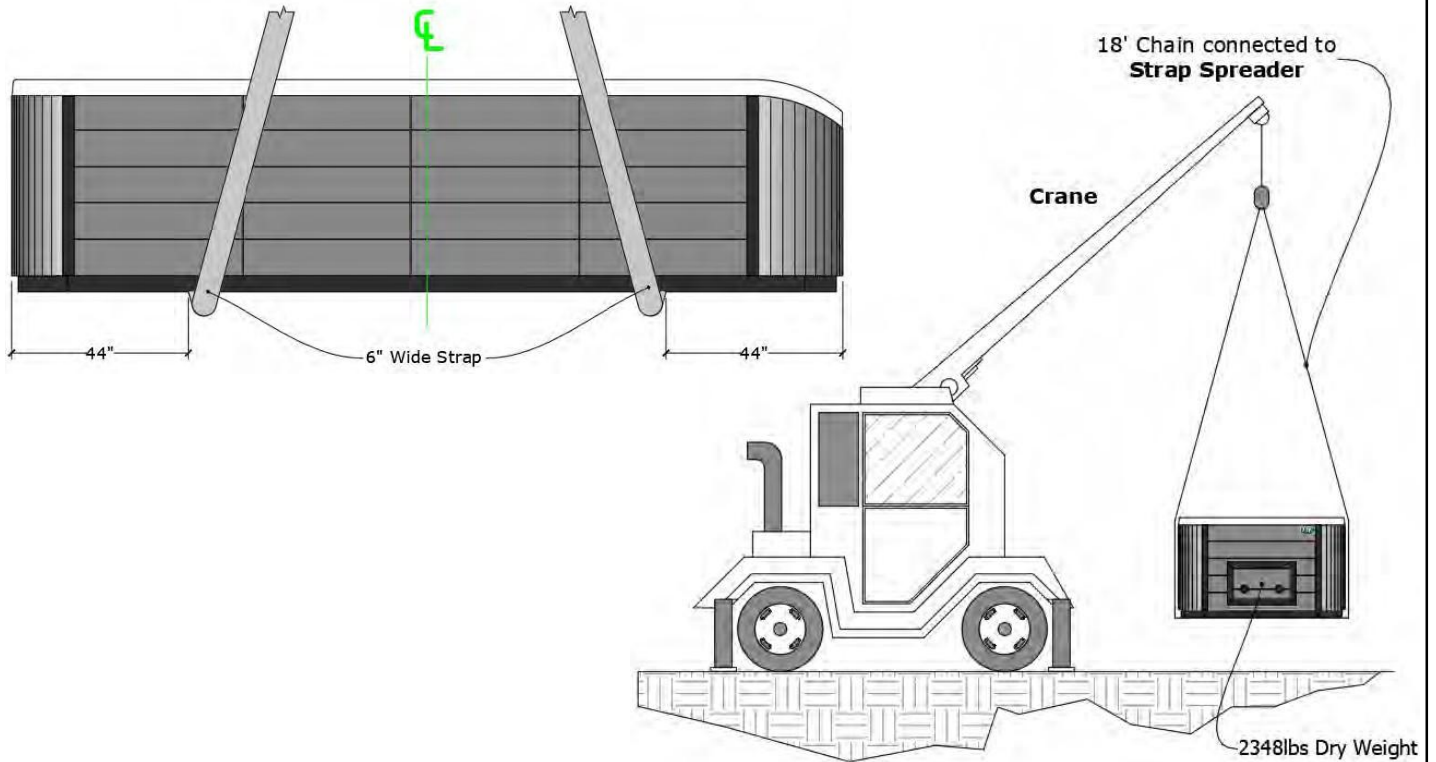



## 2100 - SAFE HANDLING / UNLOADING INSTRUCTIONS

# CAUTION!



- Use 6" wide straps that are at least 30 feet in length to support the base of the swim spa during lifting.
- Ensure the straps are in good working condition prior to unloading the swim spa (ie. No rips, wear or tear).
- Ensure the straps are evenly spaced at 66" from each end (see diagram below). Spacing the straps may require slight adjustments to ensure the load is balanced.
- The chains attached to the crane must be a minimum of 18 feet in length from the point of lifting. Using chains smaller than 18 feet will add stress to the outer lip of the spa and may result in damage.
- Using the appropriately weighted straps and chains is important to ensure the safe handling of the 2100 VE Swim Spa. Please consult your crane operator for more information.

**Note:** Damage during transportation or from mishandling or improper lifting is not covered by the CSMI Warranty.

**Note:** Never lift or handle the swim spa by the plumbing or equipment.

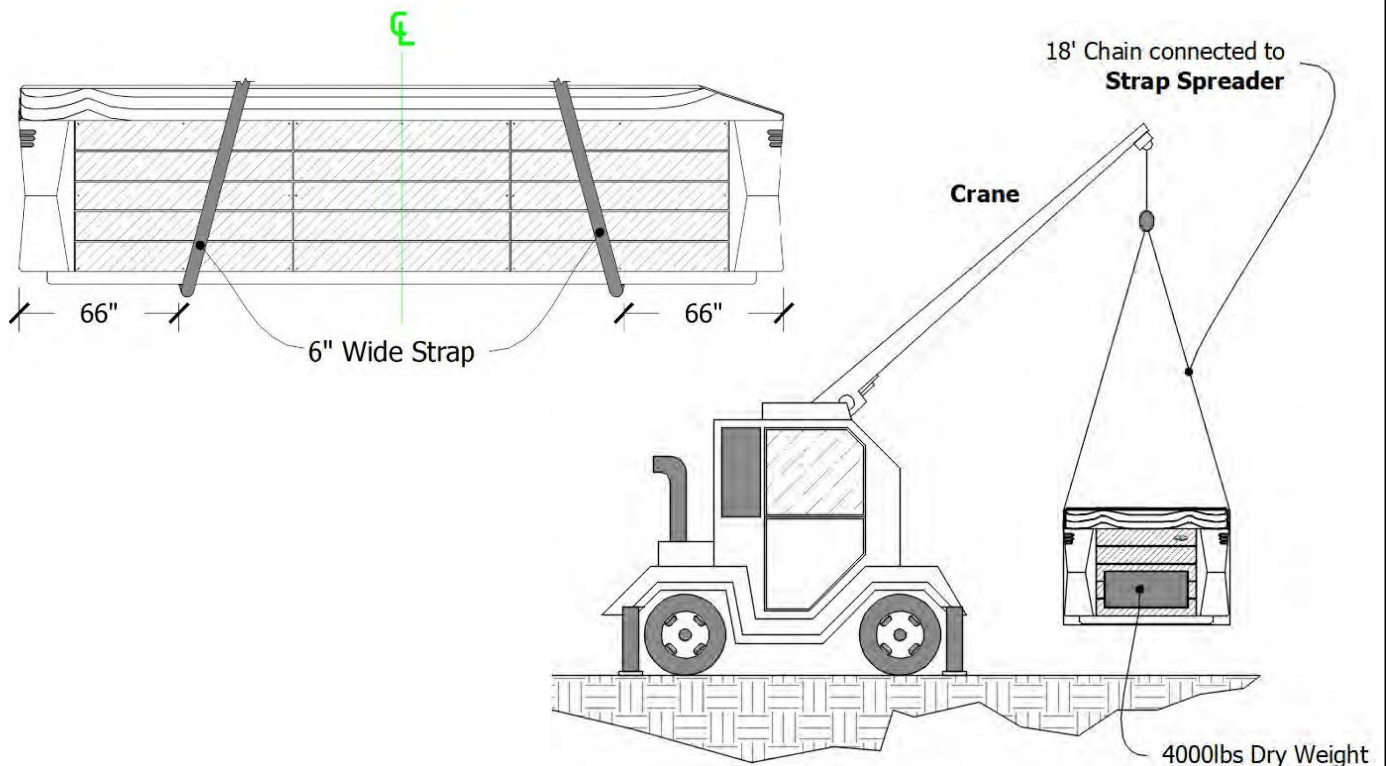

## SWIM SPA GENERAL LAYOUT

(Your swim spa may look different)

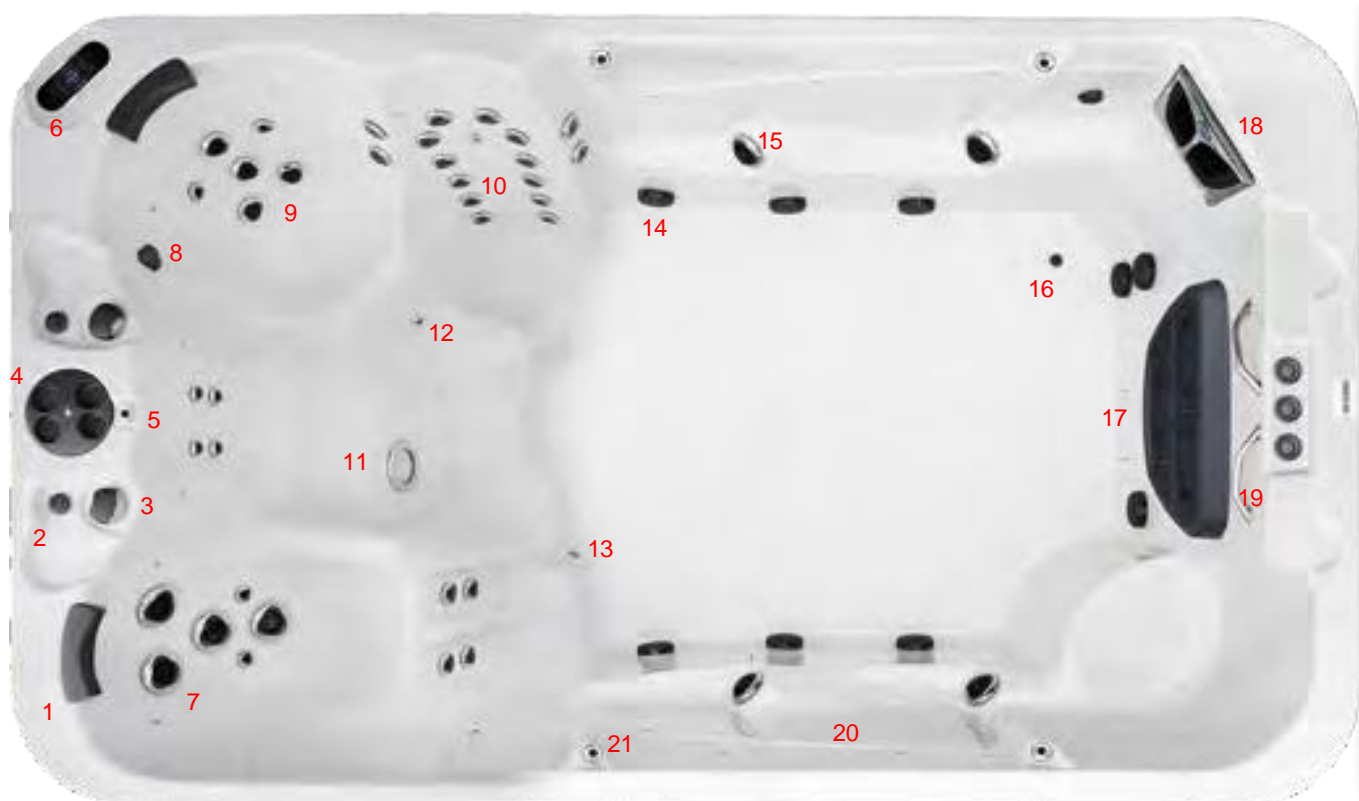

- |   |                                 |
|---|---------------------------------|
| 1. Pillows                                | 12. Ozone bleeds the shut valve |
| 2. Air Control                            | 13. Drain for Cubby/Ozone       |
| 3. Extreme XL Water Diverters             | 14. Suction                     |
| 4. Hydro Cyclonic Water Filtration System | 15. Levitator Jets              |
| 5. Swim Tether                            | 16. Spa Drain                   |
| 6. Swim Spa Control Panel                 | 17. River Jet Atlas System      |
| 7. Massage Jets                           | 18. Skimmer                     |
| 8. Laminar Shut Off                       | 19. Handles                     |
| 9. Poly Jets                              | 20. Spa LED                     |
| 10. Cluster Jets                          | 21. Laminar Flow Jets           |
| 11. 7' LED Light                          |                                 |

**DISCLAIMER:** The pictures displayed above are for reference purpose only. Some parts may be different depending upon the swim spa model.

**DISCLAIMER:** At the time of print, this manual is accurate in its information. Coast Spas reserves all the rights to change/modify any swim spa designs and/or features without notification. To check on updates or for other information, please visit [www.coastspas.com](http://www.coastspas.com).

## THE SWIM SERIES FEATURES INCLUDES

*Choose model to see specific features and options. All features below may not be included with all models.*



**Extreme XL Water Diverters LED.** Divert the flow of water to specific seats in your Spa.



**Air Controls.** Allow air to mix with the water being supplied to your massage jets.



**Our Luxury Trillium Jets.** Luxury Trillium Jets are made to deliver the ultimate hydrotherapy experience.



**Air Blower** (North America) with 18 Stainless Steel Air Injector Jets.



Our Swim Spa **River Jets** are each powered solely by a 4HP (6BHP) HyperFlow Jet Pump. The swimmer can adjust the direction of the water flow for each River Jet to ensure their swimming experience is perfect for their swimming style.



**Streaming water ropes** provides the soothing sound of running water. Adds a stunning look to the profile of the Spa.



Coast Spas developed the **Hydro Cyclonic Filtration System®**. Not only is it more efficient and faster than a skim filtration system but it also removes the dirty filter canisters from the bathing area.



**Swim Tether Anchor Plate.** Allows you to add the swim tether at any time.



**Swim Tether.** Allows you to swim in place with or without the river functioning. Helps to keep the swimmer in the center of the swim lane.



Your Spa has the ability to be equipped with the **Worldwide Spa Remote** hardware that is required to take advantage of nearly limitless control and monitoring of your Spa.



O3 One Advanced Plasma Discharge **Ozone** produces a higher concentration of energetic oxygen or "ozone" that oxidizes foreign contaminants.



The **Coast Cubby** allows for dry storage your items in a protected marine-grade compartment.



**7" Stainless Steel Frosted Light Dome.** Long lasting, bright and energy efficient.



**DM6 Dock & Bluetooth Stereo-2 Flush mount Speakers with Subwoofer:** Protective dock and enclosure for your smartphone or mp3 player.



**Aromatherapy** - Fragrance Injection System with a push of a button add a burst of fragrance into your Swim Spa.

### SPA COMFORTS

- Programmable Filtration
- Stainless Steel Oversized Monster™ Skimmer

### BUILT TO LAST

- Freeze Protection
- Formed Equipment Enclosure
- Steel Reinforced Spa Acrylic
- Pressure Treated Frame
- Quick Access Gate Valves
- Titanium Heater
- Recessed Floor Drain
- Recessed Thread-In Jet-Pockets™
- Super-Sealed™ Barb & Clamp Plumbing
- Full Swim and Exercise Area
- Anti-Slip Textured Floor
- Plush Headrests
- Beverage Holders



# START UP GUIDE

## SWIM & EXERCISE SPAS

### PREP FOR FILLING

**! PLEASE READ ALL INSTRUCTIONS BELOW BEFORE FILLING THE SPA**



Using a cloth and water, wipe away any dirt/dust collected from transport. Ensure all jets are open by turning the face counter clockwise.



Ensure all plumbing and electrical connections are securely connected and tightened as they can come loose during transit.



Ensure that any gate/knife valves are fully open.



Remove the filter lock ring and lid.



Remove filter and take it out of the plastic transport bag. Leave filter canister open when filling.



Remove skimmer cavity grate cover by sliding it upwards.



Loosen (do not remove) the air bleeder valve located in the skimmer cavity.

### FILLING YOUR SPA

**! DO NOT USE HOT WATER TO FILL YOUR SPA**

**! DO NOT USE WATER FROM A WATER SOFTENER**



Place fill hose into open filter canister and fill hot tub until water is 2/3 of the way up the skimmer opening.



When filled all massage jets (excluding neck jets) should be under water.



Remove fill hose from filter canister.



Put filter back into filter canister. Then put back on the filter canister lid and tighten locking ring.

### POWERING UP YOUR SPA



Turn power on at the main breaker.

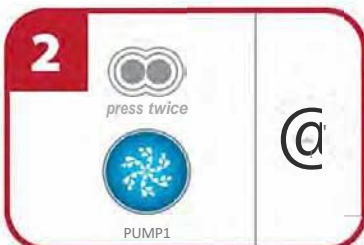

Turn pump 1 on high speed for 20 seconds by pressing the pump icon twice.



Turn pump 1 off by pressing the pump one icon once. Repeat steps 2 and 3 until air is removed from pump 1 and water is coming from jets.

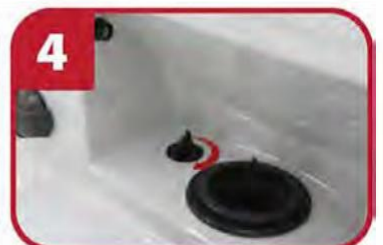

Tighten the air bleeder valve located in the skimmer cavity. Set your hot tub temperature. Get ready to enjoy!



# START UP GUIDE

## INFINITY EDGE SWIM SPAS

### PREP FOR FILLING

**PLEASE READ ALL INSTRUCTIONS BELOW BEFORE FILLING THE SPA**



Using a cloth and water, wipe away any dirt/dust collected from transport. Ensure all jets are open by turning the face counter clockwise.



If your spa has a Crystal Clear tube the threaded plug needs to be on prior to filling the spa.



Remove the filter lock ring and lid. Remove filter and take it out of the plastic transport bag.



Put the filter back inside and secure the lid firmly with the locking ring. Loosen air-bleed screw.

### FILLING YOUR SPA

**DO NOT USE HOT WATER TO FILL YOUR SPA**

**DO NOT USE WATER FROM A WATER SOFTENER**



Place fill hose inside the spa and fill main body of spa with water until it reaches the infinity edge. Allow water to spill over infinity edge for approximately 60 seconds.



Tighten air-bleed screw.



Turn power to the spa on from GFCI breaker to activate water level gauge. Continue filling until the water gauge reads just above 1/2 full.



Turn power to the spa off from the GFCI breaker for 30 seconds and then turn back on.



Do not press the back and/or pump #1 button on the control panel. Activate high speed on pumps 2 & 3 (if 3-pump model) or pump 2 (if 2-pump model) by pressing the pump buttons twice. Let run for 60 seconds.

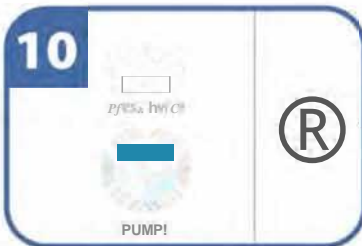

Continue running pumps 2 & 3 (pump 2 on 2-pump models), turn pump 1 on high speed for 20 seconds by pressing the pump 1 icon twice.

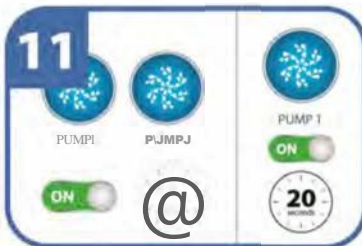

Continue running pumps 2 & 3 (pump 2 on 2-pump models) on high speed for 30 seconds and activate pump 1 on high speed for 20 seconds.



Cascade checkvalve inside the equipment area, full of water is an indication of no more air in the plumbing line. If the check valve is not full of water, air is still in the plumbing lines.



Release any additional trapped air by loosening the air bleed screw. Wait for all air to be released. Retighten.



Repeat steps 11-12 until all air has been removed from the system. If air is still in the system it will precede water coming out of the jets when pump 1 is activated.



Turn off all pumps. Then turn main power off to the spa for 30 seconds. Then turn power back on.



Your water level should read just above 1/4 on the gauge when pump 1 (high speed) is activated. **Your hot tub is now filled. Set the temperature and get ready to enjoy!**

**IMPORTANT.** Your Infinity Edge Spa will have an additional drain valve that will drain water from the reserve tank. This is separate from the main spa drain system.

## SPA CARE GUIDE

Your Authorized Dealer carries a wide variety of care and maintenance products. For more information please contact your Dealer.

### REQUIRED FILTER MAINTENANCE

Your new swim spa is equipped with a filter cartridge. To ensure maximum water quality at all times, you should replace the filter cartridge every six months, or earlier as necessary. The filter cartridge is designed to be thrown away! Attempts to reuse the filter cartridge may result in the re-release of unwanted particles back into the spa.

### PLEATCO DUAL CORE FILTERS

Your spa comes with a premium filter. Most come with equipped with a Pleatco DualCore Filter, which does a better job of cleaning your spa water than any other filter cartridge. The DualCore filter has two layers of filtration media, the outer layer and the inner layer. Both are engineered to remove different particles from your water.



The outer core is similar to a traditional filter which traps larger debris, while the inner core filters the water for particles down to 3 microns in size. The inner core is easily removed and both filter media can be cleaned.

Keeping your spa water clean and refreshing is extremely important for your enjoyment of your swim spa. Our spas come with only the best filters available in order to ensure your satisfaction.

### REQUIRED WATER REPLACEMENT

You should replace the spas water every 3-6 months. The frequency will depend on a number of variables including frequency of use, number of bathers and attention paid to the water quality maintenance. You will know it is time for a change when you can no longer get the normal feel or sparkle to the water, even though the key water balance measurements are all within the recommended ranges.

### HEADREST / PILLOW CARE

The pillows can be removed for easy cleaning and maintenance. All pillows have plugs within the pillow itself. To remove the pillow, grab the bottom edge firmly and pull outward. This will allow the pillows to pop-out from the receptacle in the spa shell. To reinstall the pillow you will align the pillow plug with the receptacle. Press/hit the front side of the pillow firmly, which will insert the plug back into the receptacle.

- Proper water chemistry must be maintained. Your swim spa pillows are easily and quickly damaged when exposed to unbalanced spa water. If you suspect that your chemicals may be unbalanced, remove your pillows immediately until the water has been restored to suggested conditions.
- Do not sit on the pillows
- Do not pull on the pillows
- Pillows should be cleaned using a soft cloth and mild soap, then wiped with a conditioner. We recommend that pillows be washed each time you drain you spa.

This Limited Warranty is void if failure is caused by accident, acts of nature, acts of God, or other causes beyond the control of CSMI. Neglect, misuse and abuse include any installation, operation, or maintenance of the spa other than in accordance with the instructions contained in the owner's manual provided with the spa, including, but not limited to damage caused by operation outside the range of 34 degrees Fahrenheit and 116 degrees Fahrenheit or 1 degree Celsius and 47 degrees Celsius .

Please be advised that the Spa Warranty will become void if Coast Spas or any of its selling or servicing agents determines that the spa has been exposed to Hydrogen Peroxide, TriChlor or any substance using it as an ingredient proven to be dangerous to the Spa. Any condition arising from the use of Hydrogen Peroxide or TriChlor on the Spa is not a warrantable defect.

### SWIM SPA INTERIOR

Your swim spa has a fiberglass reinforced acrylic shell. Generally dirt and stains will not adhere to the surface. To properly clean the surface, we recommend wiping it with a soft damp cloth (or sponge) using a low sudsing household soap or liquid detergent and rinsing thoroughly with fresh water.

Stubborn dirt or stains may be removed by using Spic & Span adequately dissolved in water. Contact your dealer and inquire about maintenance packages.

**DO NOT** use any cleaning products containing abrasives or solvents, since these could damage the surface. Harsh chemicals should never be used on acrylic surfaces. Damage to the shell due to the use of harsh chemicals is not covered under the warranty.

**DO NOT** leave your swim spa drained and in direct sunlight for extended periods of time. Extreme heat could cause damage to the acrylic surface and may induce an effect known as "crazing". Crazing is not covered under spa limited warranty.

### STAINLESS STEEL CONTROLS AND COMPONENTS ABOVE THE WATER LINE

To preserve the stainless steel finish of the controls and components above the water line, we recommend they be wiped with a dry soft cloth after each use of your swim spa. In addition, off-gas your tub by removing the cover for approximately 30 minutes multiple times per week (if not in use) and after every shock treatment.

### CABINET CARE

Never spray cabinets with a high-pressure garden hose or pressure washer for any reason. This action may induce an electrical short in the swim spa's electrical equipment.

### VINYL CABINET

Vinyl cabinets are made of a rigid polymer that combines the durability of plastic with the beauty of real wood. This cabinet is manufactured so that it won't crack, peel, blister or delaminate even after prolonged exposure to the elements. We recommend wiping the cabinet with a soft damp cloth (or sponge) using household soap or liquid detergent and rinsing with fresh water thoroughly. **DO NOT** use abrasive cleansers or material as this may damage the surface.

#### Vinyl cabinet door opening instructions



### SLATE CABINETS

Optional Slate cabinets are custom-built and painted in our factory. We recommend lightly brushing the cabinet with a SOFT bristle brush to remove any dirt or stains. For more information on the care of your Slate cabinet, please contact your Local Dealer.

#### Slate cabinet door opening instructions



### COVER CARE

A well cared for spa cover is a thing of beauty in its own right. Be sure to clean and condition your cover at least once a month – more often if needed.

Your cover needs to be cleaned and conditioned because vinyl can be dry and become brittle, spoiling your spa's appearance. Dry, brittle vinyl can also tear at the seams and stress points. Quality materials, internal sewn reinforcing and careful workmanship can only go so far against the ravages of Mother Nature. See the specific Warranty card enclosed with your cover for further details.

- When you shock your spa you need to remove the cover for a minimum of 30 minutes to ensure that the chemical gas off can escape from the spa.
- You are required to keep the spa covered at all time when not in use to protect the shell from harmful UV rays.
- A covered spa will use less electricity when maintaining the desired water temperature.
- See the manual that comes with the cover for proper mounting of the cover locks.
- The cover should remain locked at all times to prevent unauthorized entry into the spa and potential drowning.
- Do not Sit, Stand or Lie on your cover. Nor should you place any heavy object on top of the cover as this may damage the structure.

**VERY IMPORTANT:** We recommend a vinyl conditioner for your spa cover. Your local dealer carries a wide variety of care and maintenance products. Choose a pleasant day each month to remove your cover from the spa and lay it on a flat surface accessible by garden hose.

Douse the cover with a healthy amount of water from the hose or a bucket to rinse away loose dirt or debris. Using a soft bristle brush and a mild solution of dishwashing liquid (about one teaspoon of detergent to two gallons of water), and with a gentle circular motion, scrub the cover clean. Be careful not to let any areas of the cover dry before they're thoroughly rinsed. Now apply the vinyl conditioner as directed on the container. Massage the conditioner into the cover in a gentle but firm manner. Before replacing the cover on your spa, wipe and rinse any dirt from the bottom of the cover. When you are ready, put the cover on the spa.

**NOTE:** To remove tree sap, use lighter fluid (not charcoal lighter but the fluid used in cigarette lighters). Use sparingly, then immediately apply conditioner to that area.

All waterfalls and laminar flow water features should be turned off when the spa is not in use to avoid heat and water loss.

## BASIC INSTALLATION AND CONFIGURATION GUIDELINES

**WARNING!** Qualified Technician Required for Service and Installation

### ELECTRICAL REQUIREMENTS

All self contained spas use 120VAC or 240VAC electrical spa packs. These instructions describe the only acceptable electrical wiring procedures. Spas wired in any other way will void your warranty and may result in serious injury. All installations should be completed by a certified electrician. Failure to comply with state and local codes may result in fire or personal injury and will be the sole responsibility of the spa owner.

**120VAC:** This requires an isolated 15 Amp circuit breaker. This needs to be an isolated circuit with no other appliances or lights on this circuit at any time. Extension cords are not to be used in conjunction with the operations of the spa. Low voltage damage could result and this is not covered by warranty.

**NOTE:** All components must be 120V; No 240V components allowable.

**240VAC:** Depending on the model of spa, it will require either a 40 Amp, 50 Amp, or 60 Amp dedicated circuit breaker, GFCI, with the proper wire size based on the length of the run. The electrical circuit must be installed by a certified electrician and approved by a local building or electrical inspector.

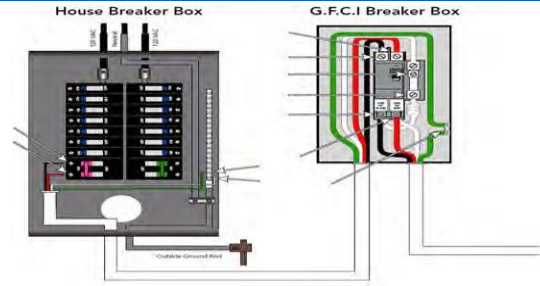

### OPTIONAL AUXILIARY HEATER

Your spa (if opted) may be equipped with two heater assemblies (main heater and auxiliary heater). Auxiliary heater requires a separate 30 AMP breaker service.

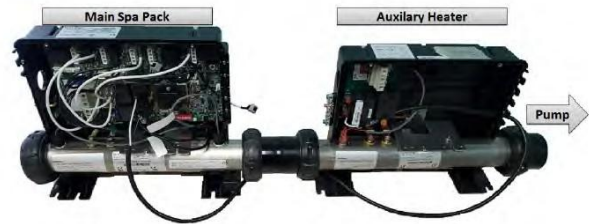

Use minimum 6AWG copper conductors only. Torque field connections between 21 and 23 in lbs. Readily accessible disconnecting means to be provided at time of installation. Permanently connected power supply.

Connect only to a circuit protected by a Class A Ground Fault Circuit Interrupter (GFCI) or Residual Current Device (RCD) mounted at least 5' (1.52M) from the inside walls of the spa and in line of sight from the equipment compartment.

### CSA ENCLOSURE: TYPE 2

Refer to Wiring Diagram inside the cover of the control enclosure. Refer to Installation and Safety Instructions provided by the spa manufacturer.

### **WARNING!** GFCI or RCD Protection.

The Owner should test and reset the GFCI or RCD on a regular basis to verify its function.

### **WARNING!** Shock Hazard! No User Serviceable Parts.

Do not attempt service of this control system. Contact your dealer or service organization for assistance. Follow all owner's manual power connection instructions. Installation must be performed by a licensed electrician and all grounding connections must be properly installed. Disconnect the electric power before servicing. Keep access door closed.

### IMPORTANT GFCI INFORMATION

Based on the testing conducted by the supplier of the true variable speed pumps, the Siemens brand GFCI can filter electrical spikes and avoid false trips. The use of a 60 Amp Siemens GFCI is recommended with the Atlas Swim System.

**DISCLAIMER:** There are no user serviceable parts in the GFCI compartment. All the services and repairs should be performed by a certified electrician only.

**CSA COMPLIANCE****CAUTION:**

- Test the ground fault circuit interrupter before each use of the spa.
- Read the instruction manual.
- Adequate drainage must be provided if the equipment is to be installed in a pit.

FOR USE ONLY WITHIN AN ENCLOSURE RATED CSA ENCLOSURE 3.

CONNECT ONLY TO A CIRCUIT PROTECTED BY A CLASS A GROUND FAULT CIRCUIT INTERRUPTER OR RESIDUAL CURRENT DEVICE.

TO ENSURE CONTINUED PROTECTION AGAINST SHOCK HAZARD, USE ONLY IDENTICAL REPLACEMENT PARTS WHEN SERVICING.

INSTALL A SUITABLY RATED SUCTION GUARD TO MATCH THE MAXIMUM FLOW RATE MARKED.

**WARNING:**

- Water temperature in excess of 38°C may be injurious to your health.
- Disconnect the electrical power before servicing.

**CAUTION:** When using this electrical equipment, basic safety precautions should always be followed.

**SWIM SPA MAINTENANCE PROCEDURES****FILTER MAINTENANCE**

The swim spa filter is one of the most important maintenance items of a spa. The filter is there to remove debris from the water and needs to be cleaned on a regular basis. Failure to do so may result in poor performance, poor water clarity and could prevent the spa from heating. Filtration starts as soon as flow is steady through the filter. As the filter cartridge removes the debris from the spa water, the accumulated debris causes flow resistance.

**CLEANING AND REPLACING FILTER CARTRIDGE**

Your swim spa filter has been designed for quick and easy maintenance. The filter cartridge should be rinsed by hose once a week and cleaned with a cartridge cleaner once a month. A second filter cartridge is recommended and will speed up this process. This can be purchased from your local dealer.



- Turn power OFF at the breaker.
- Loosen air relief valve, then remove retainer ring.
- Pull filter lid straight up to remove.
- Do not twist or pull the filter lid up on an angle. This could cause damage to the filter canister, especially in freezing conditions.
- Remove filter cartridge and clean with a garden hose and a high-pressure nozzle. Periodically you may need to soak your filter in a "cartridge filter cleaner" to remove excess minerals and/or oils.
- Rinse filter thoroughly before installing. Clean O-ring on filter lid and apply a light film of silicone lubricant to the O-ring. Do not use a petroleum-based lubricant as it could damage the O-ring. Consult your dealer to purchase suitable lubricant.
- Place clean Cartridge in filter canister.

**TOP LOAD FILTERS**

- Replace filter lid and re-tighten retaining ring (finger tight only) **NOTE:** Make sure the O-ring is on the air relief valve, and is finger tight prior to starting the pump. This O-ring should periodically be lubricated with a silicone lubricant.
- There is a 3/8" clear line coming from the filter area and this goes to the bottom corner of the spa. This drains all the water from around the filter canister.
- This is a good time to check the skimmer basket. Bring skimmer door (weir) forward and unscrew basket. Clean out debris and reinstall.

## WATER QUALITY MAINTENANCE

Maintaining the quality of the water within the specified limits will serve to enhance your enjoyment and prolong the life of the swim spa's equipment. It is a fairly simple task, but it requires regular attention because the water chemistry involved is a balance of several factors. There is no simple formula, and there is no avoiding it. An indifferent approach to water maintenance will result in poor and potentially harmful conditions for soaking and even damage to your spa investment. The most important thing to keep in mind is that preventing poor water chemistry is much easier than correcting poor water chemistry. For specific guidance on maintaining water quality, consult your Authorized Dealer who can recommend appropriate chemical products for sanitizing and maintaining your swim spa.

## MAINTAIN HEALTHY SPA WATER

**Important!** When maintaining your Swim Spa's water chemistry, ensure that your cover is removed during any aggressive treatments to allow for dissipation into the air. Take care to remove the cover slowly and chemicals deplete if you are uncertain if your water is properly balanced. Always maintain your swim spa's water chemistry within the following parameters:

**pH:** pH is a measure of relative acidity or alkalinity of water and is measured on a scale of 0 to 14. The midpoint of 7 is said to be neutral, above which is alkaline and below which is acidic. In Swim Spa water, it is very important to maintain a slightly alkaline condition of 7.2 to 7.8. Problems become proportionately severe the further outside of this range the water gets. A low pH will be corrosive to metals in the Swim Spa equipment. A high pH will cause minerals to deposit on the interior surface (scaling), cloudy water, and a prematurely dirty filter. In addition, the ability of the sanitation agents to keep the Swim Spa clean is severely affected as the pH moves beyond the ideal range. That is why almost all Swim Spa water test kits contain a measure for pH as well as sanitizer. **DO NOT** use strong acids like Hydrochloric acids or Muriatic acid to balance the pH as it could severely damage the spa shell.

**Sanitizer (Chlorine or Bromine):** To destroy bacteria and organic compounds in the Swim Spa water by breaking them down into non-harmful levels which get filtered out. A sanitizer must be used regularly, either chlorine or bromine. Sanitizing your spa water is the most important spa maintenance you can do for yourself.

**Total Alkalinity (TA)** is the measure of the dissolved alkaline agents such as carbonates and bicarbonates. These alkaline agents help prevent rapid changes in pH by acting as a pH buffer. Controlling alkalinity can help keep your pH in the appropriate range thereby lessening the need for pH balancing.

If the TA is too low the pH level will fluctuate rapidly from high to low. If the TA is too high the pH will tend to be too high and will be very difficult to bring back down.

**Calcium Hardness:** This is a measurement of dissolved calcium in the water. Calcium will help control the corrosive nature of the spa's water. Low calcium hardness causes spa and equipment corrosion whereas high calcium hardness results in cloudy water and scale build-up on the spa and the equipments.



**Look for these specialized cleaning attachments at your local dealership.**

**WARNING:** Never store chemicals inside the equipment area of your swim spa.

**IMPORTANT:** Do not use Hydrogen Peroxide based sanitizers in your swim spa. When using Chlorine or Bromine tablets you must use a floating dispenser. These chemicals can have an extremely corrosive effect on certain materials in the swim spa. Damage caused by use of these chemicals, or improper use of any chemicals, is not covered under the spa limited warranty.

**OTHER ADDITIVES:** Many other additives are available for your swim spa. Some are necessary to compensate for out-of-balance water, some aid in cosmetic water treatment and others simply alter the feel or smell of the water. Your Authorized Dealer can advise you on the use of these additives.

**IMPORTANT:** The spa or swim spa water shall be tested and treated in accordance with applicable local codes. For Pool and Hot Tub Water Sanitation, see [Uniform Swimming Pool, Spa and Hot Tub Code, Chapter 5 – Water Quality](#).

## DIVERTER MAINTENANCE

**CAUTION:** Turn off the spa from main GFCI breaker before carrying out any maintenance procedures.

### DIVERTER MAINTENANCE INSTRUCTIONS

1. Pull the diverter cap off and rotate the diverter body counter clock wise and pull out the assembly (Picture 1a to 1c).
2. Using clean piece of cloth, remove the dust particles or depositions (Picture 2).
3. Assemble the diverter body by inserting the body back by rotating the jet body clock-wise (Picture 3a). Attach the diverter cap (Picture 3b).

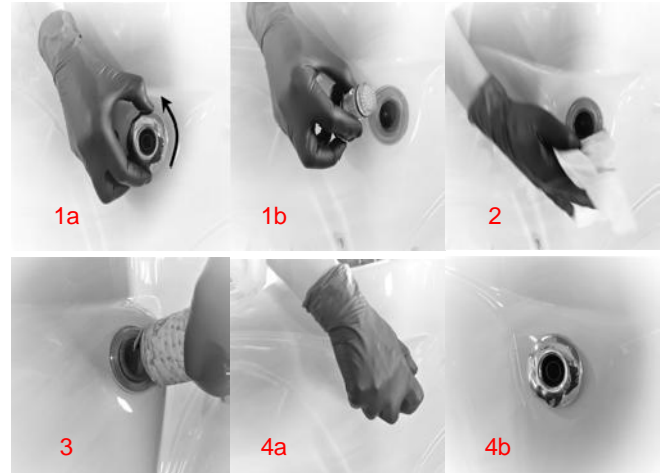
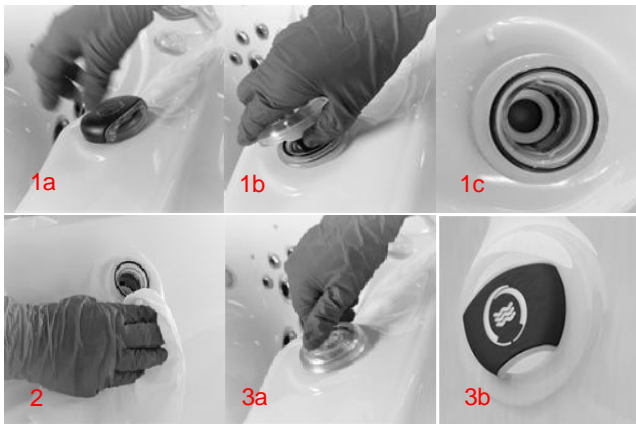

## JET MAINTENANCE

**CAUTION:** Turn off the spa from main GFCI breaker before carrying out any maintenance procedures.

It is important to regularly clean the jets to prevent any unwanted depositions and potential damage to the plumbing. It is the responsibility of the customer to regularly perform the maintenance procedures. To clean and maintain optimum jet functions, follow the maintenance instructions below.

### LAMINAR FLOW JET MAINTENANCE INSTRUCTIONS

1. Rotate counter clock wise and pull out the jet body (Picture 1a and 1b).
2. Using clean piece of cloth, remove the dust particles or debris (Picture 2).
3. Remove the unreachable debris with the help of vacuum cleaner (Picture 3).
4. Assemble the jet insert back by rotating the jet body clock-wise (Picture 4a and 4b).



CHEMICALS (USA)

Coast Spas chemicals play a vital role in ensuring the longevity, cleanliness, and overall enjoyment of your hot tub, swim spa or cold plunge experience.

For optimal performance and to ensure the longevity of your Coast Spas hot tub, swim spa & cold plunge, we strongly recommend using Coast Spas chemicals. Our specially formulated chemicals have been crafted with the utmost precision and care, utilizing premium-grade ingredients and formulations designed to complement the unique engineering of your Coast Spas hot tub, swim spas & cold plunge.

The use of alternative chemical products may lead to unintended chemical reactions, water imbalance, and possible damage to your spa's components. It is important to note that failure to use Coast Spas chemicals may impact your warranty coverage. To safeguard your investment and enjoy uninterrupted relaxation, trust in the quality and compatibility of Coast Spas chemicals — the ideal choice for your Coast Spas hot tub, swim spas & cold plunge.

SCAN THIS QR  
TO DOWNLOAD  
BROCHURE



SCAN ME



# Coast Spas®

## HIGH QUALITY FORMULATION

Coast Spas chemicals are designed to be easy to use and require minimal effort to maintain. This means that customers can spend less time worrying about maintaining their hot tubs, swim spas & cold plunge and more time enjoying them.

## EASY TO USE

Coast Spas chemicals are safe and effective, providing superior user experience for customers. They are designed to work seamlessly with Coast Spas hot tubs, swim spas & cold plunge, ensuring that customers can enjoy their hot tubs, swim spa & cold plunge without any issues.

## RELIABLE AND EFFICIENT

Coast Spas chemicals are safe and effective, providing a superior user experience for customers. They are designed to work seamlessly with Coast Spas hot tubs, swim spa & cold plunge, ensuring that customers can enjoy their hot tubs, swim spa & cold plunge without any issues.



## CHEMICALS (CANADA)

Coast Spas chemicals play a vital role in ensuring the longevity, cleanliness, and overall enjoyment of your hot tub, swim spa & cold plunge experience.

For optimal performance and to ensure the longevity of your Coast Spas hot tub, swim spa & cold plunge, we strongly recommend using Coast Spas chemicals. Our specially formulated chemicals have been crafted with the utmost precision and care, utilizing premium-grade ingredients and formulations designed to complement the unique engineering of your Coast Spas products.

The use of alternative chemical products may lead to unintended chemical reactions, water imbalance, and possible damage to your spa's components. Moreover, it is important to note that failure to use Coast Spas chemicals may impact your warranty coverage. To safeguard your investment and enjoy uninterrupted relaxation, trust in the quality and compatibility of Coast Spas chemicals – the ideal choice for your Coast Spas hot tub, swim spa & cold plunge.

**SCAN THIS QR TO  
DOWNLOAD  
BROCHURE**



## HIGH QUALITY FORMULATION

Coast Spas hot tub, swim spa & cold plunge chemicals are designed by a team of experienced chemists who understand the unique needs of hot tubs, swim spa & cold plunge. They are formulated to provide optimal performance and reliability in Coast Spas hot tubs, swim spas & cold plunge ensuring that customers can enjoy their hot tubs, swim spas & cold plunge for longer periods of time.

## EASY TO USE

Coast Spas chemicals are designed to be easy to use and require minimal effort to maintain. This means that customers can spend less time worrying about maintaining their hot tubs, swim spa & cold plunge and more time enjoying them.

## RELIABLE AND EFFICIENT

Coast Spas chemicals are safe and effective, providing a superior user experience for customers. They are designed to work seamlessly with Coast Spas hot tubs, swim spa & cold plunge, ensuring that customers can enjoy their hot tubs, swim spa & cold plunge without any issues.

## WATER CLARITY TROUBLESHOOTING

PROBLEM	PROBABLE CAUSE	POTENTIAL SOLUTIONS
<b>Water Odor</b>	<ul style="list-style-type: none"> <li>• Improper sanitization</li> <li>• Excessive organics in water</li> <li>• pH is too low</li> </ul>	<ul style="list-style-type: none"> <li>&gt; Add sanitizer</li> <li>&gt; Shock swim spa with sanitizer</li> <li>&gt; Adjust pH</li> </ul>
<b>Chlorine Odor</b>	<ul style="list-style-type: none"> <li>• Chloramines are too high</li> <li>• pH is too low</li> </ul>	<ul style="list-style-type: none"> <li>&gt; Shock swim spa with sanitizer</li> <li>&gt; Adjust pH</li> </ul>
<b>Musty Odor</b>	<ul style="list-style-type: none"> <li>• Bacteria or Algae growth</li> </ul>	<ul style="list-style-type: none"> <li>&gt; Shock swim spa with sanitizer</li> <li>&gt; Drain and refill swim spa water</li> </ul>
<b>Scale</b>	<ul style="list-style-type: none"> <li>• Total alkalinity is too high</li> <li>• pH is too high</li> <li>• High calcium content in water</li> </ul>	<ul style="list-style-type: none"> <li>&gt; Adjust total alkalinity</li> <li>&gt; Adjust pH</li> <li>&gt; Use stain and scale product</li> </ul>
<b>Stains</b>	<ul style="list-style-type: none"> <li>• Total alkalinity is too low</li> <li>• pH is too low</li> <li>• High metal content in water</li> </ul>	<ul style="list-style-type: none"> <li>&gt; Adjust alkalinity</li> <li>&gt; Adjust pH</li> <li>&gt; Use stain and scale product</li> </ul>
<b>Cloudy Water</b>	<ul style="list-style-type: none"> <li>• Poor filtration</li> <li>• pH is too high</li> <li>• Hardness is too high</li> <li>• Total alkalinity is too high</li> <li>• Suspended particles</li> </ul>	<ul style="list-style-type: none"> <li>&gt; Clean filter cartridge</li> <li>&gt; Adjust pH</li> <li>&gt; Adjust hardness</li> <li>&gt; Adjust total alkalinity</li> <li>&gt; Drain and refill swim spa water</li> </ul>
<b>Algae Growth</b>	<ul style="list-style-type: none"> <li>• pH is too high</li> <li>• Sanitizer is too low</li> </ul>	<ul style="list-style-type: none"> <li>&gt; Adjust pH</li> <li>&gt; Shock swim spa with sanitizer</li> <li>&gt; Adjust sanitizer level</li> </ul>
<b>Eye Irritation</b>	<ul style="list-style-type: none"> <li>• pH is too low</li> <li>• Sanitizer is too low</li> </ul>	<ul style="list-style-type: none"> <li>&gt; Adjust pH</li> <li>&gt; Shock swim spa with sanitizer</li> <li>&gt; Adjust sanitizer level</li> </ul>
<b>Skin Rash/Irritation</b>	<ul style="list-style-type: none"> <li>• Free chlorine level too high</li> <li>• Unsanitary water</li> </ul>	<ul style="list-style-type: none"> <li>&gt; Adjust chlorine level</li> <li>&gt; Shock swim spa with sanitizer</li> <li>&gt; Adjust sanitizer level</li> </ul>

**CAUTION:** Please follow the manual instructions carefully to troubleshoot the spa. Turn of the spa from main GFCI breaker to prevent electrical shock. All the repairs MUST be performed by a certified electrician only.

## TROUBLESHOOTING GUIDE

## SWIM SPA SYSTEM

SYMPTOM	PROBABLE CAUSE	RECOMMENDED ACTION
Swim Spa does not work	<ul style="list-style-type: none"> <li>Power is turned off</li> </ul>	<ul style="list-style-type: none"> <li>&gt; Reset GFCI</li> </ul>
No display on the control panel	<ul style="list-style-type: none"> <li>Power is turned off</li> <li>Defective control panel</li> </ul>	<ul style="list-style-type: none"> <li>&gt; Reset GFCI</li> <li>&gt; Contact your Dealer</li> </ul>
Letters on the control panel	<ul style="list-style-type: none"> <li>An error has been found</li> </ul>	<ul style="list-style-type: none"> <li>&gt; Refer to the Reference Card for your control panel to verify the error. Contact your Dealer for service.</li> </ul>

## PUMP PROBLEMS

SYMPTOM	PROBABLE CAUSE	RECOMMENDED ACTION
Noisy/Loud motor	<ul style="list-style-type: none"> <li>Air trapped in the pump</li> <li>Low water level</li> <li>Worn pump seal</li> <li>Defective pump</li> </ul>	<ul style="list-style-type: none"> <li>&gt; Open bleed valve in the skimmer</li> <li>&gt; Add water to the spa</li> <li>&gt; Contact your Dealer</li> <li>&gt; Contact your Dealer</li> </ul>
Pumps power down on their own	<ul style="list-style-type: none"> <li>Set temperature has been reached</li> <li>Filtration cycle has ended</li> <li>Automatic time out</li> <li>Overheat safety protection</li> </ul>	<ul style="list-style-type: none"> <li>&gt; No problem</li> <li>&gt; No problem</li> <li>&gt; Pumps are set to run for a predetermined time while the swim spa is in use (15-20 Mins)</li> <li>&gt; The pumps have a thermal overload which will prevent them from running for extended periods of time. Wait until pumps have cooled down (1+ hrs). If problem persists, contact your Dealer.</li> </ul>
Pump running constantly, will not turn off	<ul style="list-style-type: none"> <li>Filter cycle set to 24 hours</li> <li>Problem with the circuit board</li> </ul>	<ul style="list-style-type: none"> <li>&gt; Turn off 24 hour filtration</li> <li>&gt; Turn power off at GFCI and contact your Dealer</li> </ul>
Pump will not turn on	<ul style="list-style-type: none"> <li>GFCI tripped</li> <li>Motor has overheated</li> <li>Not plugged in</li> <li>Damaged plug</li> <li>Seized motor</li> <li>Blown fuse</li> <li>Motor vent is blocked</li> </ul>	<ul style="list-style-type: none"> <li>&gt; Reset the GFCI</li> <li>&gt; Let cool for 1+ hour</li> <li>&gt; Plug in to the board</li> <li>&gt; Contact your Dealer</li> <li>&gt; Contact your Dealer</li> <li>&gt; Check fuse or contact your Dealer</li> <li>&gt; Clear debris from the vent</li> </ul>

**CAUTION:** Please follow the manual instructions carefully to troubleshoot the spa. Turn of the spa from main GFCI breaker to prevent electrical shock. All the repairs MUST be performed by a certified electrician only.

HEAT PROBLEMS	PROBABLE CAUSE	RECOMMENDED ACTION
<b>Water will not heat</b>	<ul style="list-style-type: none"> <li>• Error message on control panel</li> <li>• Swim spa is in a different Heat Mode</li> <li>• Water level is too low</li> <li>• Poor water flow</li> <li>• Closed valves</li> <li>• Pump 1 is not running</li> </ul>	<ul style="list-style-type: none"> <li>&gt; Refer to the Reference Card for your control panel to verify the error</li> <li>&gt; Set swim spa to "Standard Mode"</li> <li>&gt; Add water to the spa</li> <li>&gt; Clean filter &amp; check valves</li> <li>&gt; Open all valves</li> <li>&gt; Contact your dealer</li> </ul>
<b>Water is too hot</b>	<ul style="list-style-type: none"> <li>• Incorrect reading</li> <li>• Filter cycle duration is too long</li> <li>• Pump speeds reversed</li> </ul>	<ul style="list-style-type: none"> <li>&gt; Verify temperature with thermometer</li> <li>&gt; Reduce duration of the filter cycle</li> <li>&gt; Contact your dealer</li> </ul>
<b>Water will not maintain heat</b>	<ul style="list-style-type: none"> <li>• Cover is off for extended periods of time in cold weather / cold wind.</li> <li>• Swim spa is wired for 110V and jets are on.</li> </ul>	<ul style="list-style-type: none"> <li>&gt; Put cover back onto swim spa and allow for heat to regenerate. Call your dealer if temperature does not increase.</li> <li>&gt; Swim spa wired for 110V only have enough power to heat or operate pumps. Turn off jets to power heater.</li> </ul>
LIGHTING ISSUES	PROBABLE CAUSE	RECOMMENDED ACTION
<b>Standard light will not come on</b>	<ul style="list-style-type: none"> <li>• Bulb has burnt out</li> </ul>	<ul style="list-style-type: none"> <li>&gt; Replace the light bulb</li> </ul>
<b>LED lighting not in sync</b>	<ul style="list-style-type: none"> <li>• Burnt out bulb/connection</li> </ul>	<ul style="list-style-type: none"> <li>&gt; Contact your dealer</li> </ul>
<b>LED lighting won't come on</b>	<ul style="list-style-type: none"> <li>• Incorrect settings</li> </ul>	<ul style="list-style-type: none"> <li>&gt; Contact your dealer</li> </ul>
PUMPS WILL NOT PRIME	PROBABLE CAUSE	RECOMMENDED ACTION
<b>Pump on but no water flow</b>	<ul style="list-style-type: none"> <li>• Air trapped in pump</li> <li>• No water in the pump</li> <li>• Closed valves</li> </ul>	<ul style="list-style-type: none"> <li>&gt; Loosen bleed valve in skimmer</li> <li>&gt; Check the fill level in the swim spa</li> <li>&gt; Open all valves</li> </ul>
HYDROTHERAPY JETS	PROBABLE CAUSE	RECOMMENDED ACTION
<b>Little to no water flowing from jets</b>	<ul style="list-style-type: none"> <li>• Jets turned off</li> <li>• Pump not primed</li> <li>• Valves are closed</li> <li>• Diverter set to a different seat</li> <li>• Dirty filter</li> </ul>	<ul style="list-style-type: none"> <li>&gt; Open jet by turning the face counter clockwise</li> <li>&gt; Reset breaker to allow for the spa to prime the pump. Open bleed valve in the skimmer area.</li> <li>&gt; Open valves</li> <li>&gt; Switch diverter</li> <li>&gt; Remove and clean filter cartridge</li> </ul>
PLUMBING SYSTEM	PROBABLE CAUSE	RECOMMENDED ACTION
<b>Water around base of spa</b>	<ul style="list-style-type: none"> <li>• Loose connections</li> <li>• Leak from internal fitting</li> </ul>	<ul style="list-style-type: none"> <li>&gt; Hand tighten all quick disconnects and fittings.</li> <li>&gt; Check gaskets and O-rings</li> <li>&gt; Contact your dealer</li> </ul>

**CAUTION:** Please follow the manual instructions carefully to troubleshoot the spa. Turn of the spa from main GFCI breaker to prevent electrical shock. All the repairs MUST be performed by a certified electrician only.

## DRAINING AND WINTERIZING

### DRAINING YOUR SPA

After a period of 3-4 months, detergent residues from bathing suits and soap film will build up in your spa water. Once this happens, your swim spa water will appear cloudy and should probably be replaced.

- Turn power OFF at the breaker.
- Locate the drain valve (usually in the equipment area).
- For infinity edge Swim Spas - Two drain valves (one for spa and another for the tank) usually located in the equipment area, could be installed unless a Water-Evac system is present.
- Remove the safety cap and attach garden hose.
- Drain water to a convenient area. (Swim spa water may harm grass or plants if sanitizer levels are high.)
- When water begins to flow out of the hose, open the air relief valve located on filter lid (Hydro-Cyclonic Filtration) or Air Bleeder Valve (Skim Filtration).
- Your swim spa will drain except for a small portion left in the foot well. This can be removed with a sponge and pail.
- Once empty, clean as required.
- To finish, remove garden hose and attach safety cap.



### WINTERIZING YOUR SPA

In many areas of the world the temperature may drop below 32°F (0°C). We recommend the swim spa is always filled with water and running at normal spa temperatures. By doing this you will minimize the risk of freezing within your swim spa. If it is necessary to leave your swim spa unattended for long periods of time during cold weather conditions, you should drain your swim spa to avoid accidental freezing caused by power outages.

Your local dealer can perform the following winterizing procedures, if you are not completely comfortable with them.

- Ensure that you have fully drained the swim spa (Refer to the DRAINING YOUR SPA section).
- After draining, your swim spa may still have water remaining in the equipment and plumbing fittings. Disconnect the hand-tightened union fittings going to and from the jet pumps. Be careful not to lose the O-rings between the unions and pump housing.

- Leave drain valve in the open position and safety cap off.
- To completely drain the plumbing lines, a wet/dry shop vacuum can be used to draw out any remaining water. Place the vacuum hose over the jet fittings in the swim spa as well as the plumbing lines in the equipment area. You should also disconnect the plug on the crystal clear inspection tube (if installed).
- Remove the filter cartridge and store in a warm, dry area.
- Clean the swim spa shell and place spa cover on spa. Be sure to lock the cover in place in case of high winds or rain.

**WARNING:** The instructions above should be followed accordingly when winterizing your swim spa however they are guidelines and potential freeze damage may still occur. All freeze damage is the sole responsibility of the swim spa owner and will not be covered by the warranty should it occur.

**EMERGENCY SITUATIONS:** To eliminate freezing in the event of equipment failure, use a 100-watt light bulb or small heater via extension cord and place it in the equipment area, keeping it away from plumbing lines. This will help for a short period of time until proper service can be rendered.



## DRAINING INSTRUCTIONS

1. On the control panel (settings) select **hold**. This will suspend all functions so that the spa can start to be drained.
2. Remove the false bottom in cabinet area.
3. Connect your hose to the hose bib located in the lower compartment. Open the hose bib valve until water starts coming out of the drain hose.
4. Turn evacuation pump power switch ON - located at the top left of the enclosure.
5. The length of time it will take to drain depends on the size of your spa. On average it will take approximately 1 hour.

**If you have an Infinity Edge Spa** allow it to drain for 30 minutes and then take it off of **hold**. Pump 1 will run on low speed to drain the tank into the main body of the spa.

Let pump 1 run on low speed until the water stops coming out of the jets/waterfall and immediately put the system back into **hold** (refer to step one).

6. Allow spa to finish draining. When fully drained, switch off the evacuation pump and close the hose bib valve.
7. Switch off power to the spa via the main GFCI Breaker.
8. You may have to use a shop vacuum to remove any excess water. Clean the spa before refilling. Refer to your Owner's Manual for proper filling instructions. Once the spa is filled, **prior to adding chemicals**, open the hose bib valve for approx. 15 seconds to allow fresh water to flush the Water-Vac™ System then close the hose bib valve.

### IMPORTANT PLEASE READ

Do not leave your spa unattended while draining. After 90 minutes the hold function is disabled and will allow your spa pumps to activate. This could cause damage to your equipment.

**SWIM SPA WELLNESS SERIES CONTROL PANEL  
(PLUNGE ONLY)**

Please click on the link below or scan the QR code to download the Control Panel user guide.

<https://coastspas.com/downloads/Classic-Collection%20Control%20Panel%20Manual.pdf>



## SWIM SPA WELLNESS SERIES CONTROL PANEL



Please click on the link below or scan the QR code to download the Control Panel user guide.

<https://coastspas.com/downloads/SwimSpaTouch3User%20Guide.pdf>



## SWIM SPA WELLNESS (9 BUTTON) PERFORMANCE PLUS WITH VARIABLE SPEED CONTROL PANEL



### INTRODUCTION

**Main Screen** - The main screen displays current time, water temperature, and status of the system accessories.

**Priming Mode** - When power is ON, the system will enter priming mode with 'Priming Mode' displayed on the panel. In this mode, all devices such as JETS, BLOWERS or LIGHT are operable. JETS can be turned on and off to prime the pump. The system will exit Priming Mode and go to the MAIN display when the RETURN button is pushed, or after 4 minutes of inactivity.

**SPA OPERATION** - Turn system accessories ON and OFF by pushing the button on the right side of panel (LIGHT, JET, THERAPY ...) These accessories have timeout defaults from the manufacturer and will turn OFF automatically after the time has expired. Default Timeout time for LIGHT is 60 minutes; THERAPY is 15 minutes; JET at low speed is 60 minutes; and JET at high speed is 15 minutes. The user can change these default times in "DEVICE TIMEOUT" setting menu.

### MENU NAVIGATION

- **MENU:** use to enter setting menu and sub-menu screens. For screens with several settable fields (example: DATE-TIME screen), use MENU button to navigate between different fields within the screen.
- **UP and DOWN:** use to navigate between different options or changing values of a field.
- **RETURN:** use to confirm the setting and goes back to previous screen.

**SETTING TEMPERATURE** - To change water Set Temperature, use UP and DOWN buttons to set the desired temperature. The screen will display "SET TEMP" with the current set temperature. After 5 seconds without change to the set temperature, the screen will go back to the MAIN screen with the current water temperature displayed. Changing the Set Temperature will turn on a pump so that the controller will be able to get an accurate water temperature and determine if the water needs to be heated.

**Heater** - When the heater pump turns on the HEATER START-UP icon will appear if heat is needed. The Heater will turn on and the HEATER icon will appear after 5 minutes.

**Panel Timeout** - If a user is in the Settings Menu and no button is pushed within 15 seconds, the screen will timeout. The current screen setting will be lost and the panel will revert back to the MAIN screen. In MAIN screen, if no button is pushed within 60 minutes, all LED and LCD lights will turn off and the panel will go to sleep. Any button pushed will wake the panel, LED and LCD lights will turn back on and the panel will Poll for water temperature.

### Enter Setting Screens

Press MENU button to display a list of Setting screens.

Use UP and DOWN to navigate between various Setting screens.



Press MENU again to enter a particular Setting screen or press RETURN to go back to MAIN screen.



## SELECTION ICONS

 FILTER CYCLE 1

 FILTER CYCLE 2

 FILTER CYCLE 3

 FILTER CYCLE 4

 LIGHT ON

 HEATER ON

 HEATER START-UP

 ENERGY SAVING HEAT MODE

 VACATION HEAT MODE

 CLEANER CYCLE

 POLLING CYCLE

 TEMPERATURE LOCK

 PANEL LOCK

 OZONE ON

 JET ON LOW SPEED

 JET ON HIGH SPEED

 BLOWER ON

 SPECIAL TEMP SELECT

 OPTION

## SWIM SPA &amp; SWIM WORKOUT

1. Press the SWIM button to turn the pump ON – the SWIM icon on the LCD screen turns ON.
2. Then press UP or DOWN button to select your desired SPEED #.
3. Press the SWIM button again to turn OFF the pump the blue SWIM icon on the LCD screen turns OFF.

## SWIM WORKOUT PROGRAMMING

1. To program the SWIM WORKOUT; press the MENU button; then UP button and select SWIM **WORKOUT** by pressing the **MENU** button to get to the **WARM UP** setting.
2. Press the **UP** or **DOWN** button to select the **SPEED #** for **WARM UP**; then press the **MENU** button to select **DURATION** in minutes; then press the **MENU** button twice to get to **WORKOUT**.
3. Press the **UP** or **DOWN** button to select the **SPEED #** for **WORKOUT**; then press the **MENU** button to select **DURATION** in minutes; then press the **MENU** button twice to get to **COOL DOWN**.
4. Press the **UP** or **DOWN** button to select the **SPEED #** for **COOL DOWN**; then press the **MENU** button to select **DURATION** in minutes; then press the **RETURN** button twice to get out of **SWIM WORKOUT**.
5. Press the **SWIM WORKOUT** button to turn **ON** the pump –the red **SWIM** icon on the **LCD** screen turns **ON**. The **WORKOUT** feature will activate to cycle each of the **SPEED** setting and specific **DURATION** setting for **WORKOUT**. If you need to increase or decrease the pump speed manually; then press the **UP** or **DOWN** button to your desired **SPEED #** in each cycle.
6. Press the **SWIM WORKOUT** button again to turn **OFF** the pump – the red **SWIM** icon on the **LCD** screen turns **OFF**.

## SETTINGS EXPLAINED

**ROTATE VIEW** - Rotate the view 180 degrees. The UP and DOWN buttons also swap when rotated. With ROTATE VIEW highlighted, press MENU to enter ROTATE VIEW setting. Use UP/DOWN to select desired setting and RETURN to confirm the setting and exit.

**SPECIAL TEMP** - To temporarily heat spa to 105°F or 106°F once, and return to previous temperature setting. With SPECIAL TEMP highlighted, press MENU to enter SPECIAL TEMP setting. Use UP/DOWN to select the desired setting and RETURN to confirm the setting and exit.

**HEAT MODE** - select STANDARD heating mode (polls every Energy Interval) for most users or ENERGY SAVING mode (polls every other Energy Interval) or VACATION mode (set temp set to 60°F). With HEAT MODE highlighted, press MENU to enter setting. Use UP/ DOWN to select the desired setting and RETURN to confirm the setting and exit.

**FILTER CYCLES** - set up filter cycle START TIME, DURATION, and DAY for filtering the spa. For FILTER CYCLE 1 and 2, if DURATION is set to ZERO the system will do a purge cycle at the start time setting. With FILTER CYCLE highlighted, press MENU to enter. Select a FILTER CYCLE and press MENU again to enter the TIME/DURATION setting screen. In this screen, press MENU to move between HOURS, MINUTES and DAYS; use UP/DOWN to change the values and RETURN to exit and confirm the setting.

FILTER CYCLES 3 & 4 by default are OFF. To set them, enter START TIME, DURATION and enable ALL DAYS or a specific day.

**DATE-TIME** - set up Date and Time for the spa. With DATE-TIME highlighted, press MENU to enter the DATE-TIME setting. In this screen, pressing MENU will move and highlight various fields that can change the setting; UP/DOWN to change the values and RETURN to confirm the setting and exit.

**DEGREE F/C** - displays spa temperature in Celsius or Fahrenheit. This option is only available for 60 Hz countries. Unit automatically displays Celsius for 50 Hz. With DEGREE F/C highlighted, press MENU to enter the DEGREE F/C setting. Use UP/ DOWN to select the desired setting and RETURN to confirm the setting and exit.

**TIME DISPLAY** - displays spa time in AM/PM or 24 hour time. With TIME DISPLAY highlighted, press MENU to enter TIME DISPLAY setting. Use UP/DOWN to select the desired setting and RETURN to confirm the setting and exit.

**GENERAL INFORMATION** - Displays general information for the spa. With GENERAL INFORMATION highlighted, press MENU to enter the GENERAL INFORMATION menu. Use UP/DOWN to view different pages and information, press RETURN to exit the page.

**LANGUAGES** - To select various languages for the spa display. With LANGUAGES highlighted, press MENU to enter and select a specific language. Use UP/DOWN to select the desired setting and RETURN to confirm the set-ting and exit.

**DEVICES TIMEOUT** - allows changes to timeout setting for various devices. LIGHT can be set to a maximum of 4 hours; PUMP in high speed and BLOWER can be set to a maximum of 1 hour; and PUMP in low speed can be set to a maximum of 2 hours. With DEVICES TIMEOUT highlighted, press MENU to enter and select various devices setting. Use UP/DOWN to select the desired time setting and RETURN to confirm the setting and exit.

**PANEL LOCK** - provides a choice to select PANEL for locking all panel buttons except MENU button; use TEMP to lock UP/DOWN button for changing set temperature; and MENU to lock MENU button (push and hold MENU button more than 15 seconds to unlock the Menu). With PANEL LOCK highlighted, press MENU to enter PANEL setting. Use UP/DOWN to select the desired setting and RETURN to confirm the setting and exit.

**NO HEAT TIME** - set the time frame for not allowing the heater to turn on. With NO HEAT TIME highlighted, press MENU to enter the NO HEAT TIME setting. In this screen, pressing MENU will move and highlight various fields that can change the setting; use UP/DOWN to change the values and RETURN to confirm the setting and exit.

**SERVICE MODE** - only available for Authorized Dealers and Spa Manufacturer.

**DEMO MODE** - To demonstrate all device capabilities of the spa. With DEMO MODE highlighted, press MENU to enter DEMO MODE setting. Use UP/DOWN to select the desired setting and RETURN to confirm the setting and exit.

**SERENITY MODE** - Set to turn off all outputs and provide quiet while in the spa. With SERENITY MODE high-lighted, press MENU to enter and select a specific time. Use UP/DOWN to select the desired time setting. Press MENU again to navigate to EXIT/START. Select the desired option and RETURN to confirm the setting and exit.

**ENERGY INTERVAL** - Only available for Non-Circ systems. With ENERGY INTERVAL highlighted, press MENU to enter the ENERGY INTERVAL setting. Use UP/DOWN to select the desired minutes (15-240) and RETURN to con-firm the setting and exit.

**SILENT TIME (FUNCTIONS PAUSE)** - Only available for Non-Circ systems. Set the time frame for no polling during night or other desired periods. With SILENT TIME highlighted, press MENU to enter the SILENT TIME setting. In this screen, pressing MENU will move and highlight various fields that can change the setting; use UP/DOWN to change the values and RETURN to confirm the setting and exit.

**CLEANER CYCLE** - Only available for Non-Circ systems. To turn on filtration after using the spa for short cleaning period. With CLEANER CYCLE highlighted, press MENU to enter and select a specific duration. Use UP/DOWN to select the desired time setting. Press Menu again to navigate to Exit/Start. Select the desired option and RETURN to confirm the setting and exit.

Error Codes Explained



Error caused when SENSOR 1 and SENSOR 3 have been plugged in incorrectly. Swap the SENSOR 1 and SENSOR 3 plug in controller to correct this problem.



Error caused by no water flow through heater or no water in heater. Check to be sure there is enough water flow through heater.



Wait for water temperature to cool down.



Wait for water temperature to cool down. Check to be sure there is enough water flow through heater.



Wait for water temperature to cool down. Check to be sure there is enough water flow through heater.



Error caused when SENSOR 1, 2, or 3 detects low temperature. All JETS and BLOWERS will turn on automatically to protect plumbing from freezing. JETS and BLOWERS will shut down when all 3 SENSORS reach a desired temperature.



Check SENSOR 1 connection



Check SENSOR 1 connection or replace SENSOR 1.



Check SENSOR 2 connection.



Check SENSOR 2 connection or replace SENSOR 2.



Check SENSOR 3 connection.



Check SENSOR 3 connection or replace SENSOR 3.

## SWIM SPA SPECIFICATIONS

Series	Model	Water Capacity (L)	Water Capacity US (Gal)	Dry Weight (lbs)	Dry Weight (kg)	Wet Weight (lbs)	Wet Weight (kg)	Dimensions (cm)	Dimensions (inches)
Plunge	1300	5320	1405	2200	998	13929	6315	384 x 229 x 135	151 x 90 x 53
Bench	1302	5320	1405	2200	998	13929	6315	384 x 229 x 135	151 x 90 x 53
1400 VE	1400	5190	1371	2223	1008	13664	6198	408 x 229 x 135	161 x 90 x 53
1600	1600	7950	2100	2990	1356	20516	9306	488 x 229 x 161	192 x 90 x 63.5
1700 VE	1700	7550	1994	2348	1065	18993	8615	525 x 225 x 135	207 x 88.5 x 53
2100 VE	2100	10487	2770	4000	1815	27121	12302	630 x 229 x 161	248 x 90 x 63.5

**DISCLAIMER:** At the time of print, this manual is accurate in its information. Coast Spas reserves all the rights to change/modify any spa designs and/or features without notification. To check on updates or for other information, please visit [www.coastspas.com](http://www.coastspas.com)

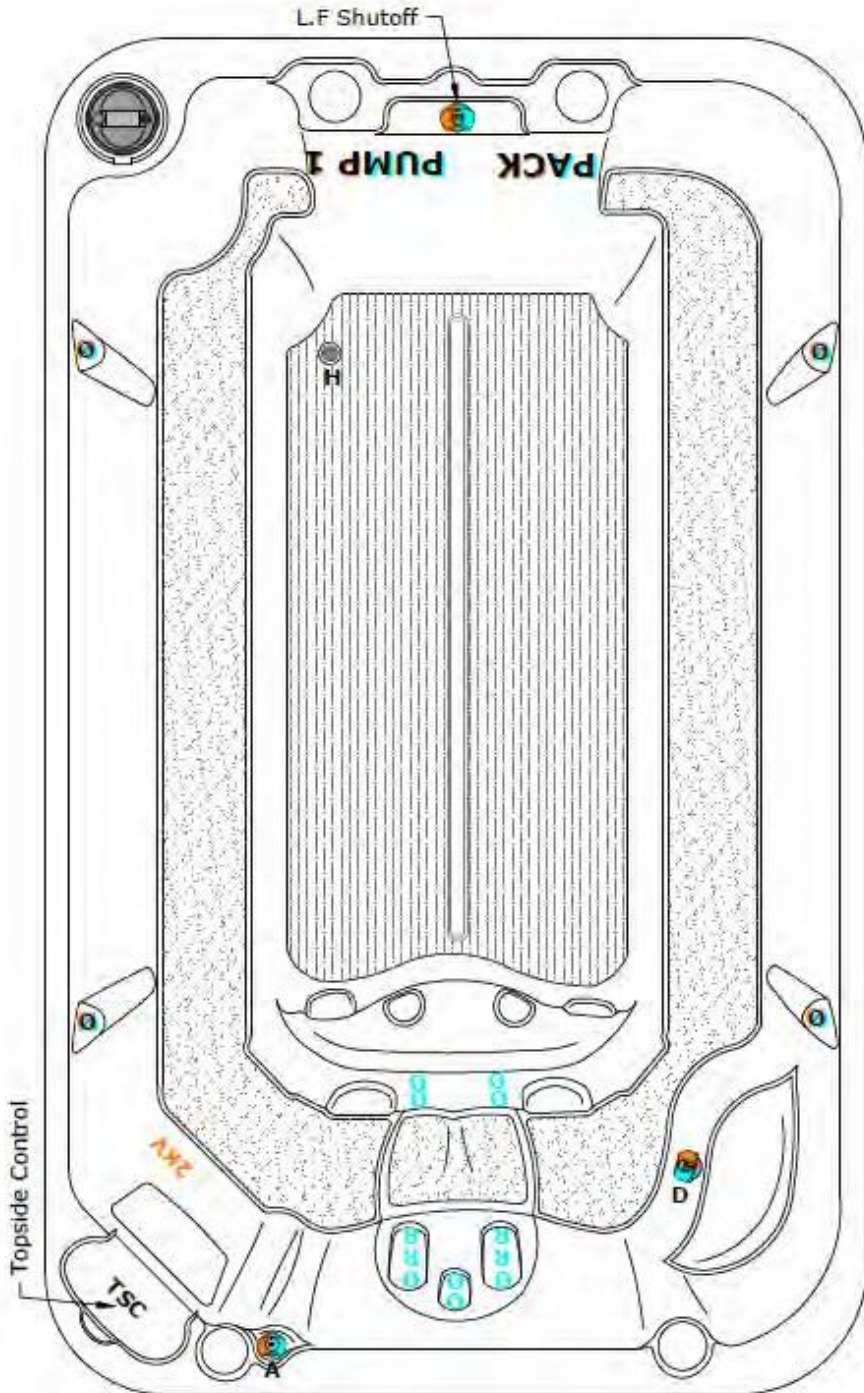

## SWIM SPA JET OPERATIONS 1300 PLUNGE SERIES



**JET Note:**

Ø	=	Cluster Jet
R	=	Poly Jet
2K	=	Storm Jet
2KV	=	Volcano Jet
C.J	=	Carousel Jet

**Diverter Control**

	=	Blue (Right)
	=	Orange (Left)

**L.F. Shutoff**

<b>ON</b>		<b>OFF</b>
	(BLUE, ORANGE)	

**Air Control General Note:**

<b>ON</b>		<b>OFF</b>
	(BLUE, ORANGE)	

**DISCLAIMER:** At the time of print, this manual is accurate in its information. Coast Spas reserves all the rights to change, modify any spa designs and/or features without notification. To check on updates or for other information, please visit [www.coastspas.com](http://www.coastspas.com)

## SWIM SPA JET OPERATIONS 1302 BENCH LIFESTYLE SERIES

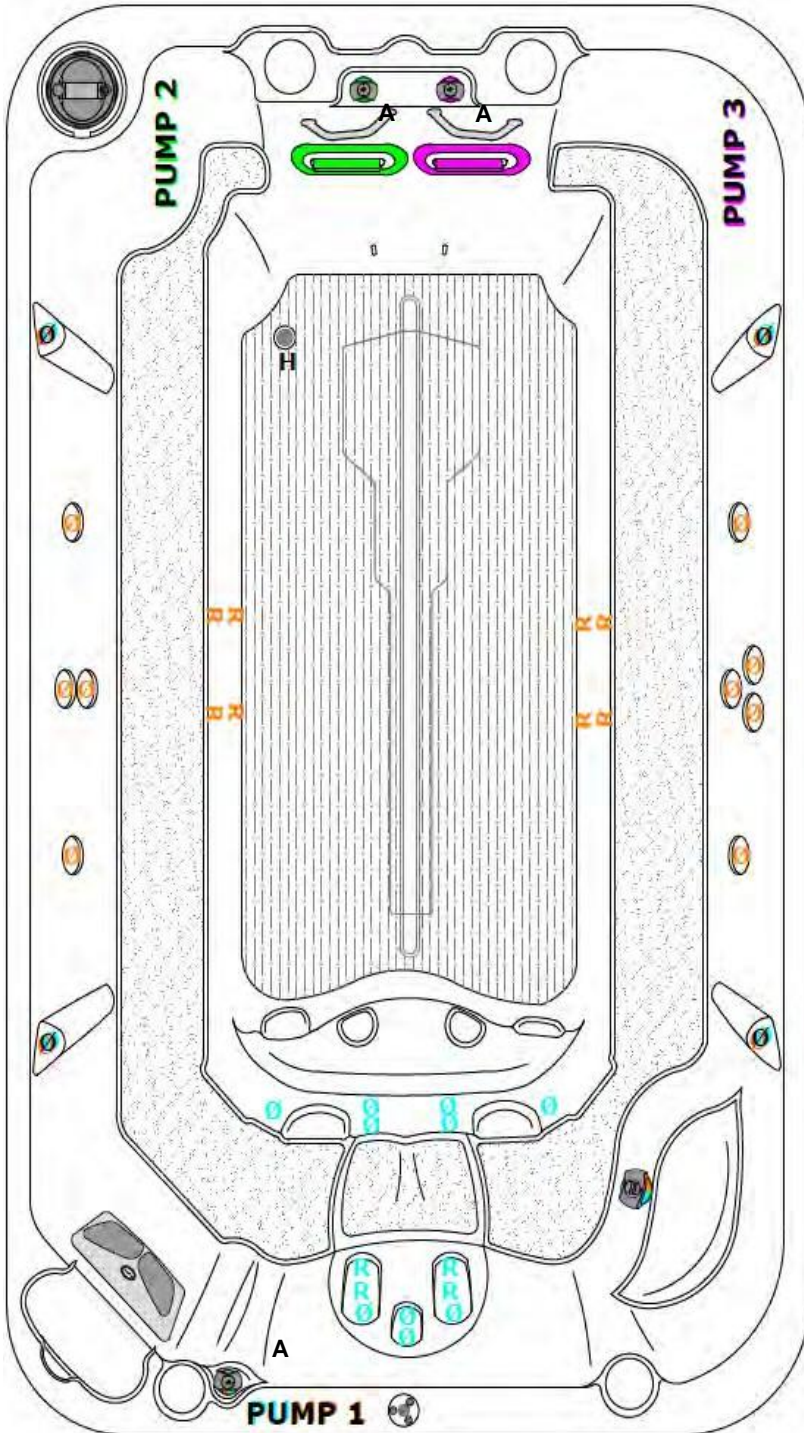

	<b>PUMP 1</b>
	<b>PUMP 2</b>
	<b>PUMP 3</b>

**JET Note:**

Ø	=	Cluster Jet
R	=	Poly Jet
2K	=	Storm Jet
2KV	=	Volcano Jet
	=	River Jet

**Water Diverter Control**

	=	Blue (Right)
	=	Orange (Left)

**Air Control General Note:**

**ON** ( ) **OFF**  
(GREEN, MAGENTA)  
(With Check Tee)  
\*Rotate All The Way

(BLUE) **ON** ( ) **ON** (ORANGE)  
(ORANGE) **OFF** ( ) **OFF** (BLUE)



**WATER DIVERTER OPERATION GUIDE**

- Turning water diverter "RIGHT" will operate the jets colored in **BLUE**.
- Centre position will keep all the jets flowing on low strength.
- Turning water diverter "LEFT" will operate the jets colored in **ORANGE**.

**DISCLAIMER:** At the time of print, this manual is accurate in its information. Coast Spas reserves all the rights to change/modify any spa designs and/or features without notification. To check on updates or for other information, please visit [www.coastspas.com](http://www.coastspas.com).

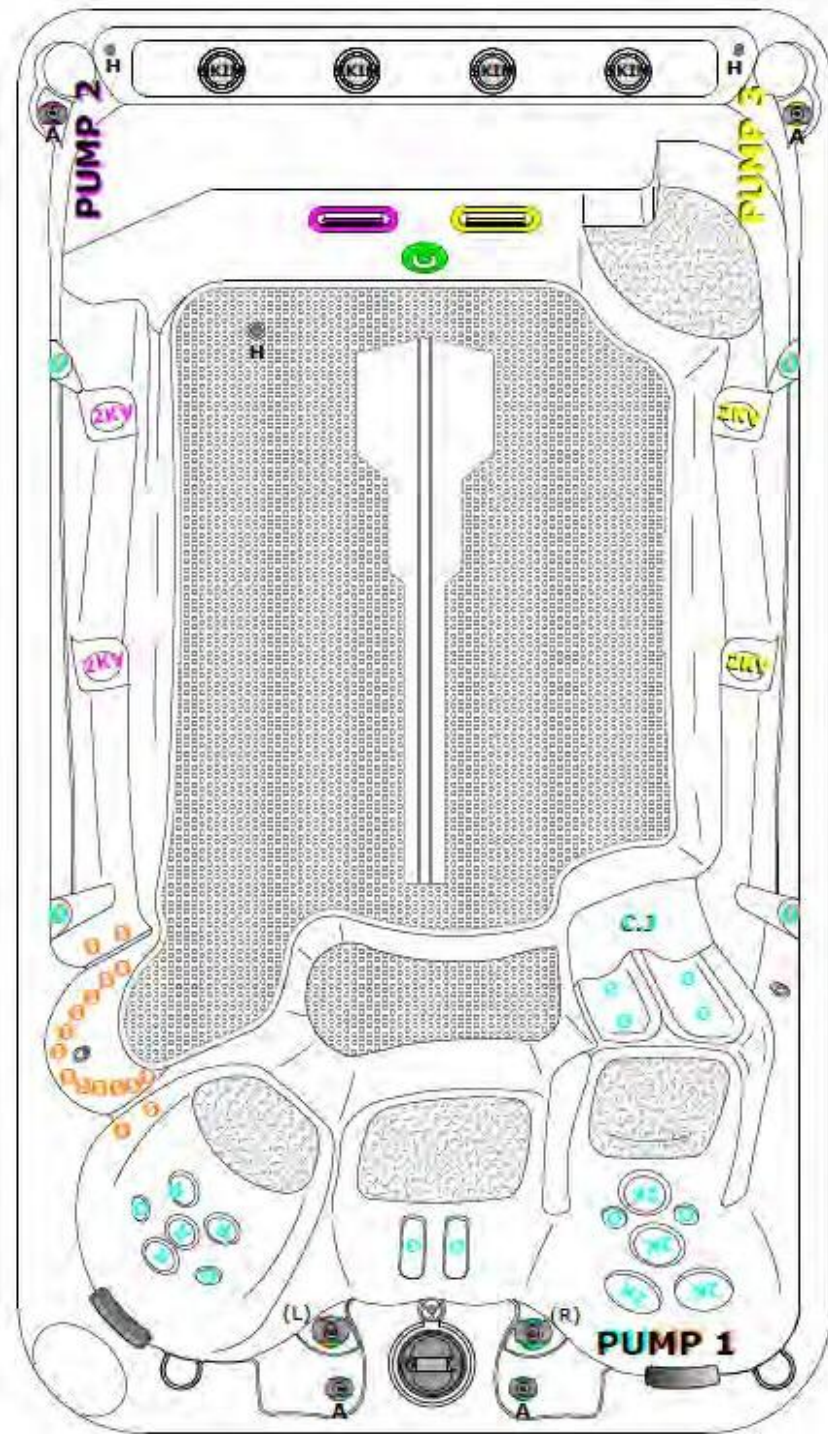



## SWIM SPA JET OPERATIONS 1400 VE LIFESTYLE SERIES



	<b>PUMP 1</b>
	<b>PUMP 2</b>
	<b>PUMP 3</b>

JET Note:	
Ø	= Cluster Jet
R	= Poly Jet
2K	= Storm Jet
2KV	= Volcano Jet
	= River Jet



**Water Diverter Control**

-  = Green (Right)
-  = Blue (Left)
-  = Orange (Right)
-  = Blue & Green (Left)

**Air Control General Note:**

**ON**  **OFF**  
(GREEN, MAGENTA, YELLOW)

*(With Check Tee)*  
*\*Rotate All The Way*

**(BLUE) ON**  **ON (ORANGE)**  
**(ORANGE) OFF**  **OFF (BLUE)**

**WATER DIVERTER OPERATION GUIDE**  
There are 2 water diverters in 1400 swim spa.  
**DIVERTER "R"**

-  Turning water diverter "RIGHT" will operate the jets colored in **GREEN**.
-  Centre position will keep all the jets flowing on low strength.
-  Turning water diverter "LEFT" will operate the jets colored in **BLUE**.





**DIVERTER "L"**

-  Turning water diverter "RIGHT" will operate the jets colored in **ORANGE**.
-  Centre position will keep all the jets flowing on low strength.
-  Turning water diverter "RIGHT" will operate the jets colored in **BLUE** and **GREEN**.

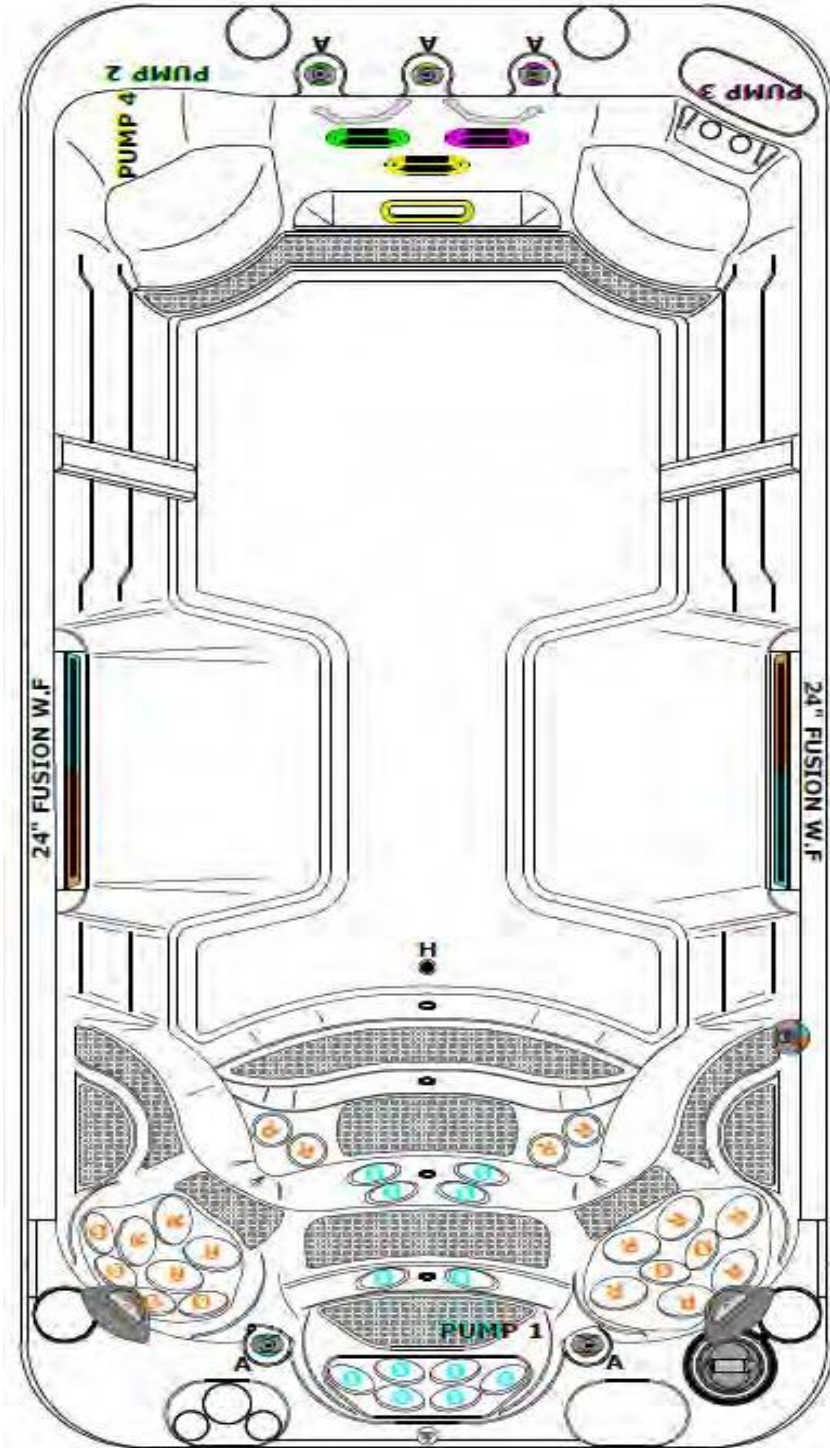
**DISCLAIMER:** At the time of print, this manual is accurate in its information. Coast Spas reserves all the rights to change/modify any spa designs and/or features without notification. To check on updates or for other information, please visit [www.coastspas.com](http://www.coastspas.com).

## SWIM SPA JET OPERATIONS 1600 PERFORMANCE SERIES





	<b>PUMP 1</b>
	<b>PUMP 2</b>
	<b>PUMP 3</b>
	<b>PUMP 4</b>
	<b>PUMP 4</b>

**JET Note:**

∅	= Cluster Jet
R	= Poly Jet
2K	= Storm Jet
2KV	= Volcano Jet
	= River Jet



**Water Diverter Control**

	= Blue (Right)
	= Orange (Left)

**Air Control General Note:**

**ON**  **OFF**  
(BLUE, ORANGE, GREEN, MAGENTA, YELLOW)

**WATER DIVERTER OPERATION GUIDE**

	Turning water diverter "RIGHT" will operate the jets colored in <b>BLUE</b> .
	Centre position will keep all the jets flowing on low strength.
	Turning water diverter "LEFT" will operate the jets colored in <b>ORANGE</b> .

**DISCLAIMER:** At the time of print, this manual is accurate in its information. Coast Spas reserves all the rights to change/modify any spa designs and/or features without notification. To check on updates or for other information, please visit [www.coastspas.com](http://www.coastspas.com).

## SWIM SPA JET OPERATIONS 1700 VE PERFORMANCE SERIES

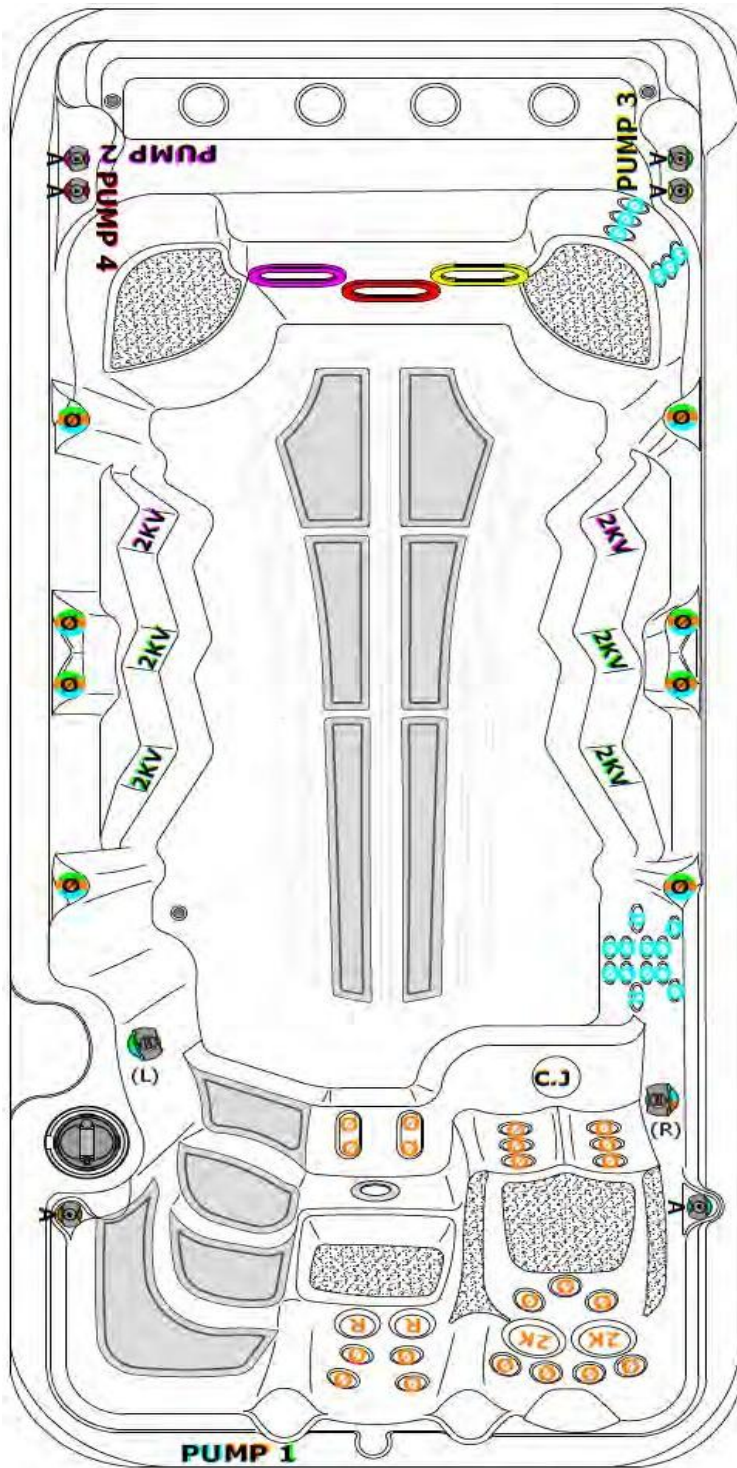





	<b>PUMP 1</b>
	<b>PUMP 2</b>
	<b>PUMP 3</b>
	<b>PUMP 4</b>

JET Note:	
Ø	= Cluster Jet
R	= Poly Jet
2K	= Storm Jet
2KV	= Volcano Jet
	= River Jet

**Air Control General Note:**

**ON**  **OFF**  
(BLUE, ORANGE, GREEN, MAGENTA, YELLOW, RED)



**Water Diverter Control**

	= Orange (Right)
	= Blue (Left)
	= Green (Right)
	= Blue & Orange (Left)



**WATER DIVERTER OPERATION GUIDE**

There are 2 water diverters in 1700 swim spa.

**DIVERTER "R"**

-  Turning water diverter "RIGHT" will operate the jets colored in **ORANGE**.
-  Centre position will keep all the jets flowing on low strength.
-  Turning water diverter "LEFT" will operate the jets colored in **BLUE**.

**DIVERTER "L"**

-  Turning water diverter "RIGHT" will operate the jets colored in **GREEN**.
-  Centre position will keep all the jets flowing on low strength.
-  Turning water diverter "RIGHT" will operate the jets colored in **BLUE** and **ORANGE**.

**DISCLAIMER:** At the time of print, this manual is accurate in its information. Coast Spas reserves all the rights to change/modify any spa designs and/or features without notification. To check on updates or for other information, please visit [www.coastspas.com](http://www.coastspas.com)

## SWIM SPA JET OPERATIONS 2100 VE PERFORMANCE SERIES

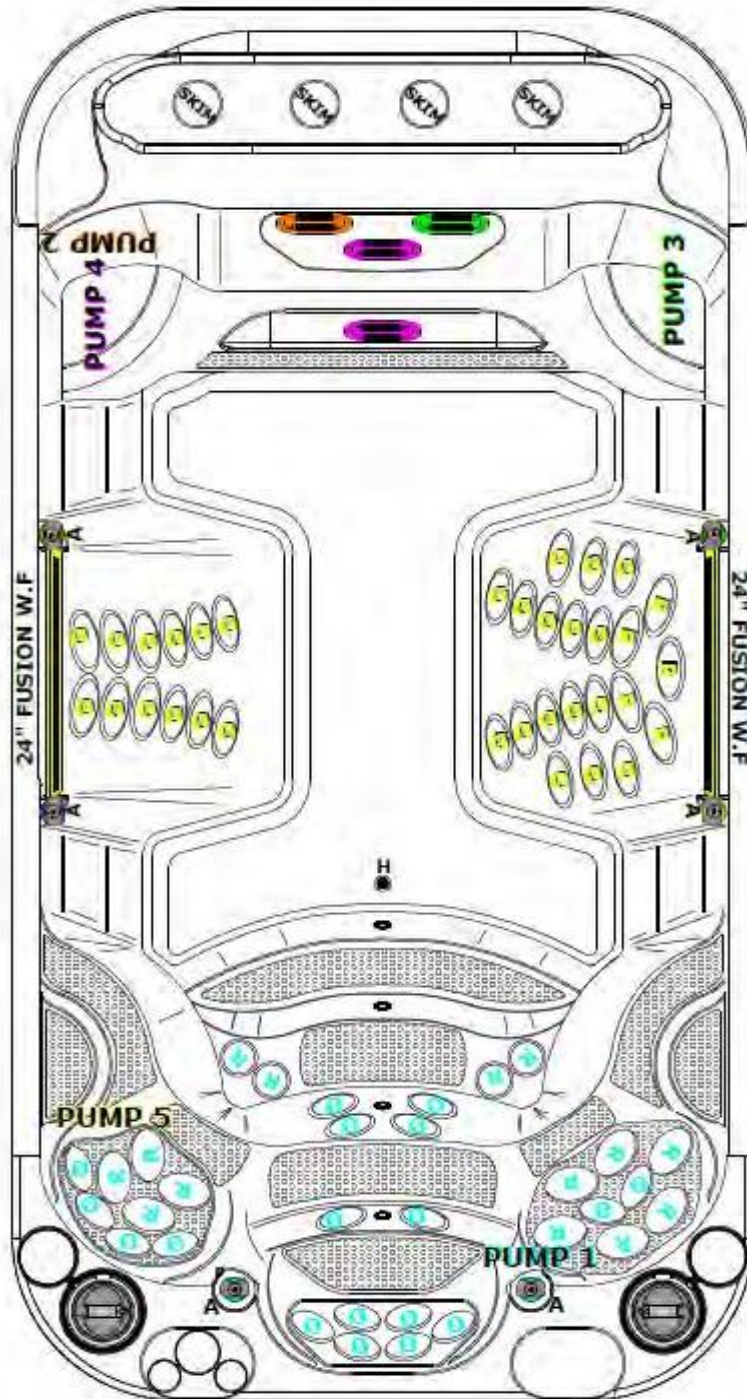

	<b>PUMP 1</b>
	<b>PUMP 2</b>
	<b>PUMP 3</b>
	<b>PUMP 4</b>
	<b>PUMP 5</b>

**JET Note:**

∅	= Cluster Jet
R	= Poly Jet
2K	= Storm Jet
2KV	= Volcano Jet
	= River Jet

**Air Control General Note:**

**ON** (  ) **OFF**  
(BLUE, ORANGE, GREEN, MAGENTA, YELLOW)

**DISCLAIMER:** At the time of print, this manual is accurate in its information. Coast Spas reserves all the rights to change/modify any spa designs and/or features without notification. To check on updates or for other information, please visit [www.coastspas.com](http://www.coastspas.com)

**BALBOA WI-FI MODULE**

With the Balboa Wi-Fi Module installed in your spa follow the steps below to setup/configure the device.

**Step 1:** Download the app from the Google Play store or the iTunes store. The app will be titled “Coast Spas—Spa Remote” (Google) or Coast Spas—Remote Spa Control (iTunes).

**Step 2:** Make sure your Wi-Fi on your device is enabled. Check your device’s instructions on how to access Wi-Fi Settings.



**Step 3:** While standing at the spa select the Wi-Fi Module from the list of available devices from your device’s Wi-Fi menu. The Wi-Fi device will appear as BWGSpa\_XXXXX in the list.



**Step 4:** Once connected to the Wi-Fi Module directly open the Coast Spas app. The Coast Spas app will allow you to control and interact with the spa while you are still with in range.



Selecting “Controls” will open a list of installed components like pump(s), blower, lights, etc.

**Note:** This screen will vary depending on installed components.

Selecting “Settings” will open the settings menu. While connected to the spa will be able to set the temperature, change the degrees between °F or °C, alter the heat mode (Ready/Rest), select the temperature range (low or high), set the time of day, input filter cycles (time start and duration) and have access to the advanced menu.

For more information on the various settings please refer to the selection in the owner’s manual for your control panel.

**CONNECTING TO THE HOME NETWORK**

**Note:** You can only connect the Wi-Fi app to the house network when connected directly to the Wi-Fi Module. See “Getting Started” to connect directly to the Wi-Fi Module.

Once connected to the Wi-Fi Module navigate to:

Settings ► Advanced ► Wi-Fi Settings

**Step 5:** Select your routers security setting. This will vary and if the wrong setting is selected the app will not be able to access the spa.

**Step 6:** Set your home network. Each router will have its own unique SSID (Service Set Identifier).

**Step 7:** Enter your key. The key will be the passkey used to sign in on your network.



**Note:** If you do not know or need assistance locating any of the information above please contact your locale service provider.

**CONTROLMYSPA™ (LUXURY MODELS ONLY)**

**CMS™ SYSTEM CONSISTS OF:**



WEBSITE

ControlMySpa™ website with Login and access to spas

**CMS™ GATEWAY ULTRA Modules**



Home Module



Spa Module

[www.balboawater.com/GatewayUltra](http://www.balboawater.com/GatewayUltra)

**SMARTPHONE | TABLET**



iOS (Apple) ControlMySpa™ mobile app and/or Android ControlMySpa™ Mobile app

The ControlMySpa™ system consists of:

- ControlMySpa™ GATEWAY ULTRA installed on a spa/Hot Tub
- iOS (Apple) ControlMySpa™ mobile app or Android ControlMySpa™ mobile app
- ControlMySpa™ website with log-in and access to spas

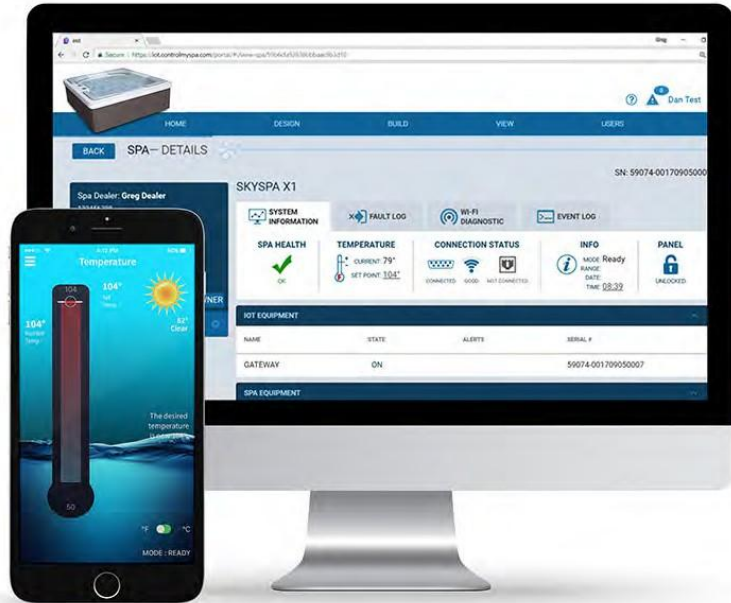

The ControlMySpa™ Logins:

- The iOS or Android ControlMySpa™ apps can only be accessed with an owner log-in
- The ControlMySpa™ website can be accessed with an owner log-in.

**ControlMySpa™ App for the smart device**

**FOR IPHONE® OR IPAD® (IOS/APPLE)**

Search the Apple iOS App Store for “controlmyspa” Or

Use this link: <https://goo.gl/j31t1V>



**FOR ANDROID® PHONES/TABLETS**

Search Google Play App Store for “controlmyspa”

Or Use this link: <https://goo.gl/CG4Yci>



ControlMySpa™

**Connect GATEWAY ULTRA hardware in your home**

**Step 1**

Plug the supplied ethernet cable into the home router (A).

**Step 2**

Plug the other end of the ethernet cable into the GATEWAY ULTRA module (B).

**Step 3**

Plug the supplied power cord into the GATEWAY ULTRA module (C).

**Step 4**

Plug the other end of the supplied power cord into wall power (D).



GATEWAY ULTRA Module (side view)

**LED Light Chart (E)**

This chart applies to the home and spa GATEWAY ULTRA modules.

- Red - Solid: The GATEWAY ULTRA and the spa are not connected.
- Red - Blinking: Home and spa GATEWAY ULTRA modules are connected, but no connection to the spa controller.
- Blue - Blinking: Remote software update is underway. Do not unplug power.
- Green - Blinking: CMS™ GATEWAY ULTRA spa and home modules RF is connected, but no connection to internet.
- Green - Solid: Spa successfully connected to internet. No errors.

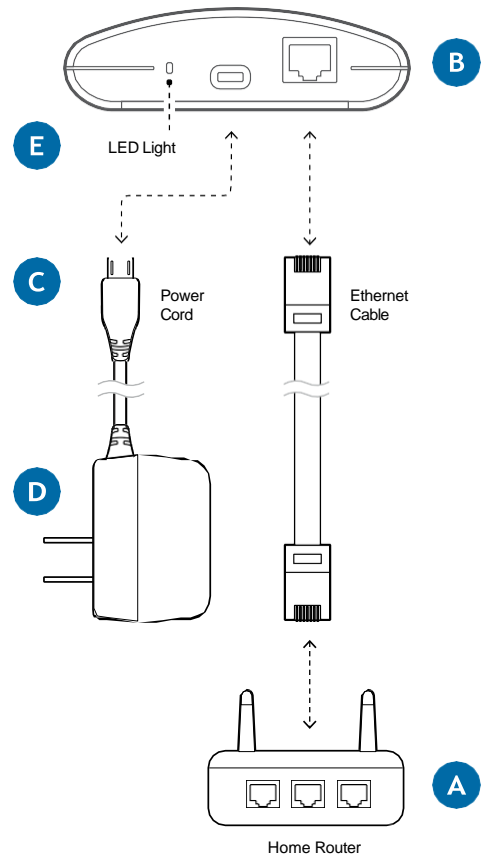

## CMS™ Code Overview

### WHAT IS A CMS™ CODE?

- CMS™ Code is an 8 digit letter/number combination that all Spa owners must have to use spas equipped with the ControlMySpa™ system
  - A) The CMS™ code is obtained from your Dealer.
- Spa owners will need this CMS™ code to setup and connect their spas in the ControlMySpa™ database.
- The CMS™ code connects your spa to your OEM and Dealer for service and support

### EXAMPLE CMS™ Code: ABC-12345

ABC = 3 letter code unique to each spa Manufacturer or OEM 12345 = 5 number code unique to each spa Dealer or Distributor

## ControlMySpa™

### Setup Spa Owner User Account



- 1. Open the app on your smart device**  
Press "SETUP" on the app.



- 2. Press "Next"**  
Confirm Bluetooth is ON in the iOS Settings.



- 3. Press "Next"**  
Stand near your spa (within 10 feet/3 meters) and ensure the spa power is ON by pressing the topside panel. If the spa is powered ON, press "Next".



- 4. Detect Bluetooth**



**5. Press "Yes"**  
 The serial number in the app should match the serial number on the back of the spa module.



**6. Press "Next"**  
 The CMS code is provided by your Dealer. Press "Next".



**7. Press "Next"**  
 Input information and press "Next".



**8. Press "Next"**  
 Input information and press "Next".



**9. Press "Next"**  
 Input information and press "Next".



**10. Press "Next"**  
 Your UserID and password will appear. Press "Next".



**11. Press "Close"**

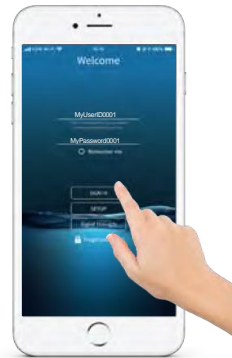

**12. Press "SIGN IN"**  
 Input your email address, password and press "SIGN IN".

**SUCCESS! YOUR ACCOUNT IS SETUP, AND YOU CAN CONTROL YOUR SPA WITH THE CMS APP.**

## BALBOA BLUETOOTH AUDIO



bba3 Amplifier

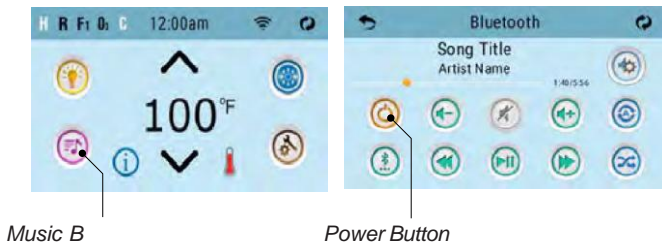

Music B

Power Button

### Pairing Smart Device

- Power up the system pack with bba2 already connected to the system pack.
- On the control panel press the music button. Next, press the power button.
- Turn on Bluetooth function of your smart device or music device.
- On your smart device or music device, click search for Bluetooth device. Make sure you are close enough to the spa tub.
- On your smart device, select "BBA Spa Music" from the pairing list. If "BBA Spa Music" does not appear, repeat steps previous steps.
- Some smart devices will connect automatically and others you will need to select "Connect." Once connected, this icon  will appear. Play music on your smart device. If the music plays from the speakers in the spa, the connection is complete.

**NOTE:** bba3 operates up to 100 feet in open air. Ranges vary as they are dependent on installations.

### Bluetooth Screen



- |                                   |                                     |
|-----------------------------------|-------------------------------------|
| A - Back                          | J - Track Forward                   |
| B - Progress Bar                  | K - Volume Up                       |
| C - Song Title, Artist            | L - Play/Pause                      |
| D - Screen Title: Bluetooth       | M - Mute                            |
| E - Song Progress                 | N - Track Back                      |
| F - Invert Display                | O - Volume Down                     |
| G - Settings                      | P - Input Modes: Bluetooth, Line in |
| H - Shuffle                       | Q - Power                           |
| I - Repeat: one song or all songs |                                     |

### Adjust Settings

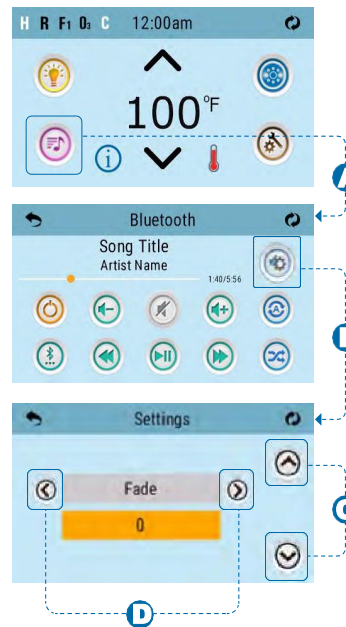

1. Follow these steps to adjust the audio settings. Press the Music button (A) to enter the Bluetooth screen.
2. Press the Settings button (B) to enter the Settings screen.
3. Press these buttons (D) to select an audio setting. The audio settings are listed below.
4. Press these buttons (C) to change the setting's value.

#### SETTINGS

- Balance
- Fade
- EQ Preset
- Filter
- Bass Gain

*There are two types of filters: Low Pass and High Pass. These filters apply to the rear speaker output only. Select Low Pass for subwoofers or High Pass for tweeters. Select OFF if filtering is not desired. Normal speakers do not require filtering.*

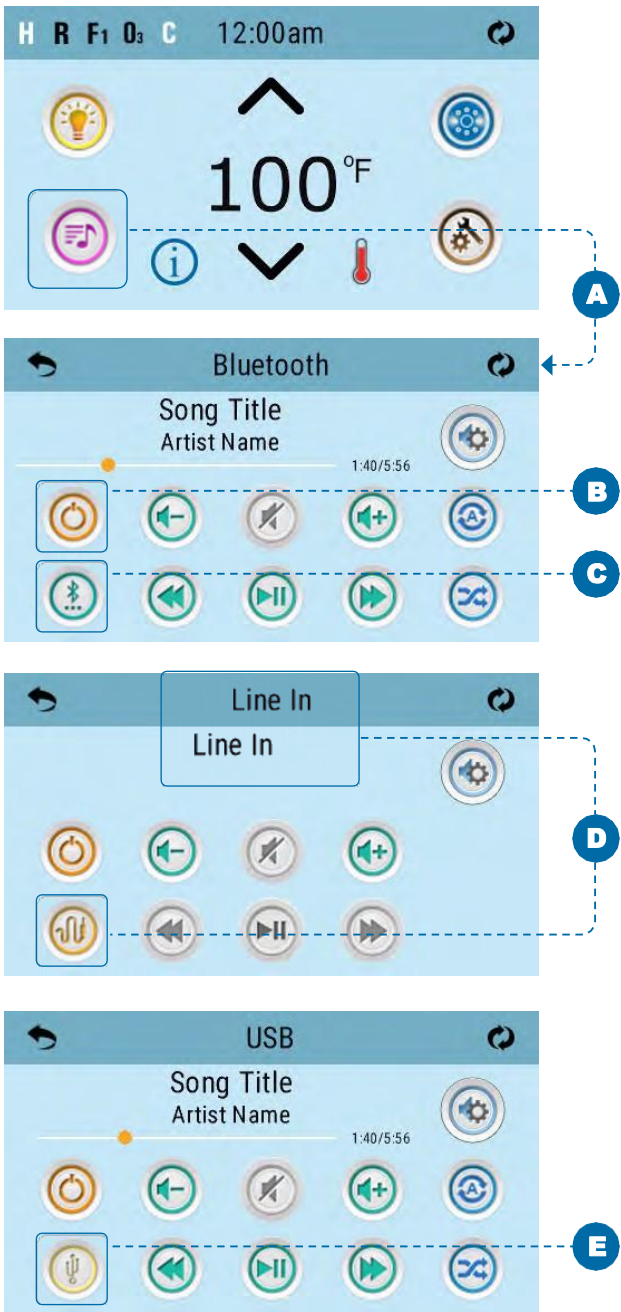

### SELECT INPUT MODE

The following input modes are available: Bluetooth, Line In. All control systems are equipped with Bluetooth mode. However, control systems may or may not have Line In, as this input mode is optional.

Follow these steps to select the input mode of the bba™3 amplifier.

1. Press the Music button (A) to enter the Bluetooth screen.
2. Confirm that the bba™3 amplifier is turned On. If it is turned Off, the button icon (B) will be gray.
3. Press the Input button (C) to select one of the following input modes:

**Bluetooth (C).**

**Line In (D)**

**USB (E)** - USB is not available with the bba™3 amplifier, even though the icon may appear on the panel.

Line In mode (D) allows you to connect any headphone output to the Aux In connectors (F), but you will likely need an adapter cable because of the different connectors.

Only audio settings such as Volume are available when using Aux In (F).

The terms "Line In" (D) and "Aux In" (F) refer to the same thing.

### INPUT MODE ICONS

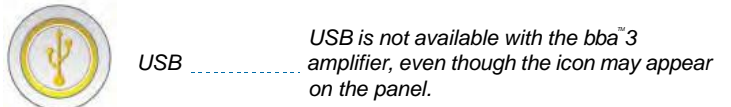

bba™3 Amplifier

**TROUBLESHOOTING**

**Scenario 01**

**Problem:** The error message "BT Comm Lost" (A) appears on the panel display.

**Solution:** The control system has lost communication with the bba™3 amplifier (B). Contact customer support for help.

**Scenario 02**

**Problem:** When you try to connect your music device to Aux In on the bba™ amplifier, the Aux In connectors on your bba™ amplifier are different than these (C).

**Solution:** Your spa is equipped with an earlier version of bba™ (1 or 2). Contact customer support for help.

**Scenario 03**

**Problem:** Song title appears only sometimes or never.

**Solution 1:** A few music player apps never send song title and other info over Bluetooth, so try another app. Also, some music player apps don't send song title if playing automatically in the background, only if the app is "visibly running" on the device, so try "opening" the app which is playing in the background.

**Solution 2:** If the song title never appears, this can happen for a couple of other reasons. One, you may have an older bba™ amplifier. Two, you may have an older panel. Contact customer support for help.

**Scenario 04**

**Problem:** When you press the music button (A) or select A/V, it does not go to the Bluetooth screen.

**Solution:** If the screen it takes you to has a Bluetooth button (B), select that Bluetooth button to continue.

That Bluetooth button (B) may not appear if the control system (E) did not detect the bba™3 amplifier (D).

**NOTE:** This can appear on multiple panels. The spaTouch™2 screens on this page are used to illustrate the scenario.

**Scenario 05**

**Problem:** The Shuffle and Repeat buttons do not work on my panel.

**Reason:** Some music players/devices do not support Shuffle and/or Repeat.

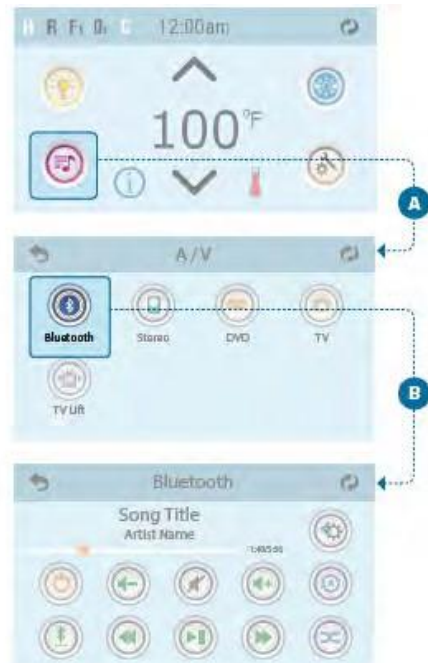
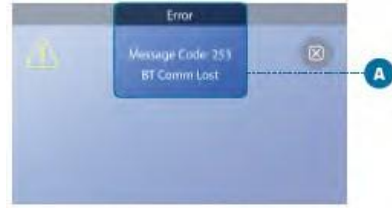

## COAST STATUS



### Compatible with BP Spa Packs:

North American (NA) Packs: 56689-03 and 56683-05

European (EU) Packs: 56688-04 and 56690-03

Coast Status is designed to give real time status of the spa. LED's will be tied to a cabinet mounted light fitting that the spa owner can use to tell, at a glance, if all is OK with the spa or if something requires their attention. Coast Status Warning messages shown below.

### Coast Status Lighting Legends

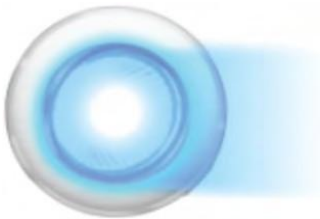

#### Steady Blue Light

Spa pack is operational. There are no messages, faults or error codes.



#### Flashing Blue Light

Spa pack is operational. There is a reminder and/or message. There is no fault. *Example: Message code 40 - this code requests you to set the time.*

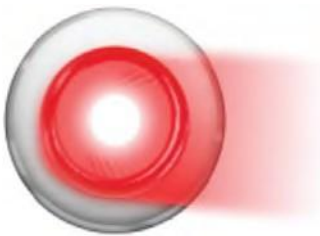

#### Steady Red Light

There are warning messages or faults present.



#### Flashing Red Light

Severe warnings or faults present.

To check message on the Control Panel screen, tap on  icon.



**COAST STATUS MESSAGES**

Message #	Message Text	Message #	Message Text	Message #	Message Text
0	<none>	20	The clock has failed	36	The GFCI test failed
1	Possible freezing condition	21	The settings have been reset	37	Hold (aka Standby) Mode
2	Test the GFCI	22	Program memory failure	38	Run Jets 1 to get temperature
3	Change the filter	23	Configuration error (Call for service)	39	Test software installed
4	Clean the filter	24	Darin Mode	40	Set the time
5	Treat the wood	25	Demo Mode	43	Change UV
6	Clean the cover	26	Sensors are out of sync (Call for service)	44	J29
7	Change the mineral cartridge	27	The heater is dry	45	The water level is too low
8	Change the water	28	The heater may be dry	47	Check Ozone
9	Check the sanitizer	29	The water is too hot	48	Service Check-Up
10	Check the pH	30	The heater is too hot	49	Check the filter now
15	Sensors are out of sync	31	Sensor A fault (Call for service)	248	Chromazon Fault: Too Many Lights
16	The water flow is low	32	Sensor B fault (Call for service)	250	Chromazon Fault: Not Responding
17	The water flow has failed	34	A pump may be stuck on	253*	BT Failure
19	Priming Mode	35	Hot fault (Call for service)	254*	Communications error (Call for service)

## COAST SPAS ECOCLEAN UV STERILIZER



### HOW IT WORKS

- Ultraviolet germicidal UV lamps are low pressure mercury vapor lamps which produce the UV-C dose necessary for microorganism's eradication.
- This dose (mJ/cm<sup>2</sup>) is the result of a design taking care of the flow rate, the water transmittance, reactor size and exposure time.
- Ultraviolet light is generated by an electrical discharge through low pressure inert gases and mercury vapor with the special quartz tube of the lamp.
- UV Rays generated at 254 Nm are germicidal at the optimal wavelength for eradicating micro-organisms
- Eradicates organisms that can actually live in a chlorinated environment.
- Your EcoClean UV Sterilizer imparts nothing into the water, making it an eco-friendly, reliable and effective choice.
- The sterilizers UV Bulb should be replaced and its protective quartz tube cleaned every 18 months.
- The UV-C rays of our sterilizer take care of in-line sanitation however, weekly shocking of the water is advisable to oxidize any chloramines or contaminants. An ozonator is also recommended as an excellent complimentary device for oxidation.

### EASY MAINTENANCE

- Your NEW Coast Spas EcoClean UV Sterilizer is installed out of sight, concealed by your spa skirt. Quick access is gained through simply removing one skirt panel.
- Replacement of the UV lamp: Every 13 000 operating hours
- Clean quartz tube at time of lamp replacement (12 to 18 months)
- Remember to keep the recommended free residual of chlorine or bromine in the water as required in your specific region (Canada 3 to 5 ppm of chlorine or bromine).
- Made in the U.S.A (UL/CE/EPA Approved)

### QUICK FACTS

- The unique quartz tube of the EcoClean UV Sterilizer blocks out all but UV-C 254 Nm rays. Any less and a sterilizer is less effective for spas. Similarly, if a sterilizer exceeds this intensity, it will break down chlorine or bromine and be less effective as a result.
- Although you should keep your spa water balanced, balancing chemicals do not alter the effectiveness of the sterilizer, as it neutralizes 99.9% of viruses and bacteria.
- Because the EcoClean UV Sterilizer is eliminating chloramines and organisms in-line, the free chlorine or bromine, of which you still must maintain recommended levels, is more efficient – you can save up to 70% in sanitizing chemical use.



**Forward Leg Lift**

Start with feet together flat on pool bottom. Lift one leg up to the side and hold for 10 seconds. Repeat. Alternate legs between sets.



**Outer Thigh Abductor**

Keeping your backside straight against the pool wall, pull one leg out to the side and hold for 10 seconds. Repeat. Alternate legs between sets.

**Inner Thigh Abductor**

Keeping your backside straight against the pool wall, pull one leg in towards the front and hold for 10 seconds. Repeat. Alternate legs between sets.

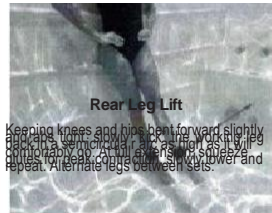

**Rear Leg Lift**

Keeping knees and hips bent forward slightly, pull one leg back to the starting position and hold for 10 seconds. Repeat. Alternate legs between sets.

**Inner Thigh Abductor**

Keeping your backside straight against the pool wall, feet shoulder width apart and knees locked, pull inside leg across the front of opposite leg just past the outer foot. Slowly return to start position and repeat. Alternate legs between sets.



**Standing Bicep Curl**

Start with your palms facing forward, arms straight, holding handles towards your upper chest. Bend your elbows and slowly raise your arms to hip level keeping elbows bent.



**Standing Reverse Forearm Curl**

Start with your palms facing backward, arms straight, holding handles toward your upper chest. Bend your elbows and slowly raise your arms to hip level keeping elbows bent.



**Lateral Arm Extension**

Start with hands to your sides. With elbows bent, raise arms to sides until elbows are shoulder level. Maintain elbows bent above or equal to wrist. Lower and repeat.

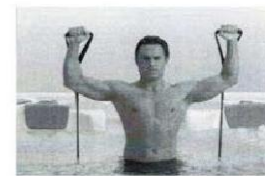

**Standing Military Press**

Start with your arms and elbows held out to the sides. Press straight upward and overhead. Lower to your starting point, then repeat. Do not lean back. Press upward again.



**Standing Calf Raises**

Stand straight with your feet spread apart and firmly planted on the pool bottom. Position your hands at your shoulders. Rise up on your heels. Hold the position for 10 seconds. Lower to the starting position. Repeat the exercise for several sets, with a rest period in between.



**Standing Butterfly**

Stand straight with your feet spread apart. Push your arms forward and overhead. Push your arms together while keeping your chest raised to your starting position. Return to the starting position by separating your arms.



**Reverse Lateral**

Stand straight with your feet spread apart. Push your arms back and overhead. Push your arms together while keeping your chest raised to your starting position. Return to the starting position by separating your arms.

### Rowing Exercise

- Install Rowers**  
Press the quick release button. Snap the back of the rowing bar into the mount.
- Install First Set of Tension Cords**  
Use the mounting loops as a slip knots around each safety bar. Clip tension cord to mounting loop.
- Install Second Set of Tension Cords**  
Choose a desired pair of the varying length tension cords. Clip the tension cord to the mounted loop.

**Rowing**  
Sit in the rowing seat and cross the rower handles to begin your rowing exercise. Bend forward at the waist and keep your back flat. Slowly draw your hands towards your chest while simultaneously leaning back until your torso is perpendicular to the floor. Hold the position for a few seconds. Slowly return to the starting position by straightening your back and extending your arms forward. Repeat the exercise for several sets, with a rest period in between.

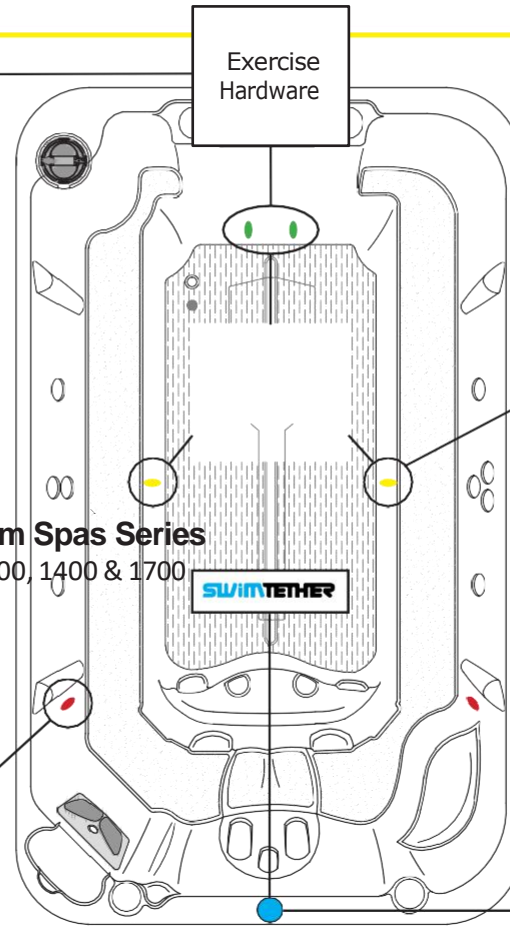

### Treadmill with Swim Tether

- Install Swim Tether Pole**  
Attach the three poles together by inserting the thinner top pole into the middle section and the middle into the thicker base pole. Place bottom of the pole into the attachment on the lip of the pool, above the rowing seat. Adjust nylon rope to desired length.
- Install Waist Band**  
Pull the stainless steel clip along the waist band to adjust belt's diameter. Strap waist belt attachment to your waist by buckling the smaller clip into the larger, angled clip.

**Treadmill**  
Run in place, utilizing water resistance.

### Advanced Swimming with Swim Tether

- Install Waist Band**  
Strap waist belt attachment to your waist by clipping the smaller clip into the larger angled clip.

**Swimming with Added Resistance**  
Practice advanced swimming techniques and swim at a faster rate with the waist attachment.

For more information on the installation and use of the Swim Tether, please visit the "documents" section of [www.SwimTether.com](http://www.SwimTether.com)



● **Install Tension Cords**  
Choose a desired pair of the varying length tension cords. Clip the tension cords to the mounted loops. Attach handles to the tension cords.



**Forward Leg Lift**

Start with feet together, flat on pool bottom. Lift one leg forward until parallel with pool bottom. Lower and repeat. Alternate legs between sets.



**Outer Thigh Abductor**

Keeping your backside straight against the pool bottom, lift one leg out to the side until parallel with pool bottom. Lower and repeat. Alternate legs between sets.



**Inner Thigh Abductor**

Keeping your backside straight against the pool bottom, lift one leg out to the side until perpendicular to the pool bottom. Lower and repeat. Alternate legs between sets.



**Rear Leg Lift**

Keeping knees and hips bent forward slightly and feet flat on pool bottom, lift one leg straight back. Lower and repeat. Alternate legs between sets.



**Standing Bicep Curl**

Start with your palms facing forward, arms extended in front of you. Slowly curl your arms up to your shoulders. Lower and repeat.



**Standing Reverse Forearm Curl**

Start with your palms facing backward, arms extended in front of you. Slowly curl your arms up to your shoulders. Lower and repeat.



**Lateral Arm Extension**

Start with hands to your sides. With elbows at shoulder height, maintain elbows just above or equal to wrist. Lower and repeat.

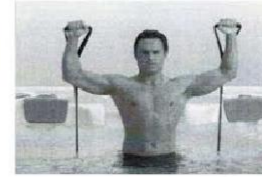

**Standing Military Press**

Start with your arms and elbows held out to the sides. Press straight up and overhead. Lower to just above your head and repeat.



**Standing Calf Raises**

Stand straight with your feet spread apart. Rise up on your heels as far as possible while keeping your knees slowly return to the starting position. Repeat for several sets, with a rest period in between.

### Rowing Exercise

- Install Rowers**  
Press the quick release button. Snap the back of the rowing bar into the mount.
- Install First Set of Tension Cords**  
Use the mounting loops as a slip knots around each safety bar. Clip tension cord to mounting loop. Clip tension cord to rowing bar.
- Install Second Set of Tension Cords**  
Choose a desired pair of the varying length tension cords. Clip the tension cord to the mounted loop. Clip the tension cord to the row bar.

**Rowing**  
Sit in the rowing seat and grasp the rowing handles. Keep your rowing exercise form forward slightly at the waist and to draw your hands back slowly draw your hands towards your chest while simultaneously leaning back until your torso is perpendicular to the floor. Hold the position for a few seconds. Slowly return to the starting position by straightening your back and extending your arms forward. Repeat the exercise for several sets, with a rest period in between.

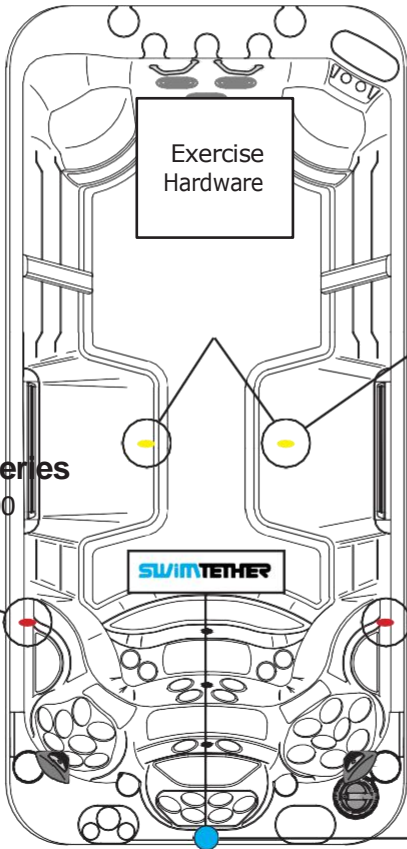

Swim Spas Series  
1600 & 2100

**Standing Tri-cep Curl**  
Start with your arms fully extended above your head, elbows slightly bent, shoulders relaxed. Keeping elbows pointed forward, close to your ears. Lower first behind your head downward. Hold momentarily then push up to the starting position.

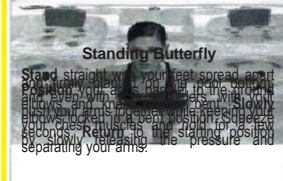

**Standing Butterfly**

Stand straight with your feet spread apart. Press your arms forward at the front of the pool. Pull your arms back over your head. Release your arms and pull forward. Repeat for several sets, with a rest period in between.

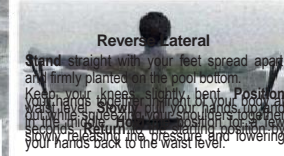

**Revers Lateral**

Stand straight with your feet spread apart and firmly planted on the pool bottom. Keep your knees slightly bent. Push your hands up and out to the sides. Lower and repeat. Repeat for several sets, with a rest period in between.

### Treadmill with Swim Tether

- Install Swim Tether Pole**  
Attach the three poles together by inserting the thinner top pole into the middle section and the middle into the thicker base pole. Place bottom of the pole into the attachment on the lip of the pool, above the rowing seat. Adjust nylon rope to desired length.
- Install Waist Band**  
Put the stainless steel clip along the waist band to adjust bolt's diameter. Strap waist belt attachment to your waist by buckling the smaller clip into the larger, angled clip.

**Treadmill**  
Run in place, utilizing water resistance.

### Advanced Swimming with Swim Tether

- Install Waist Band**  
Strap waist belt attachment to your waist by clipping the smaller clip into the larger angled clip.

Swimming with Added Resistance  
Practice advanced swimming techniques and swim at a faster rate with the waist attachment.

For more information on the installation and use of the Swim Tether, please visit the "documents" section of [www.SwimTether.com](http://www.SwimTether.com)



**Install Tension Cords**  
Choose a desired pair of the varying length tension cords. Clip the tension cords to the mounted loops. Attach handles to the tension cords.





**WORLD'S BEST BUILT SPAS**